

Wireless World

RADIO and ELECTRONICS

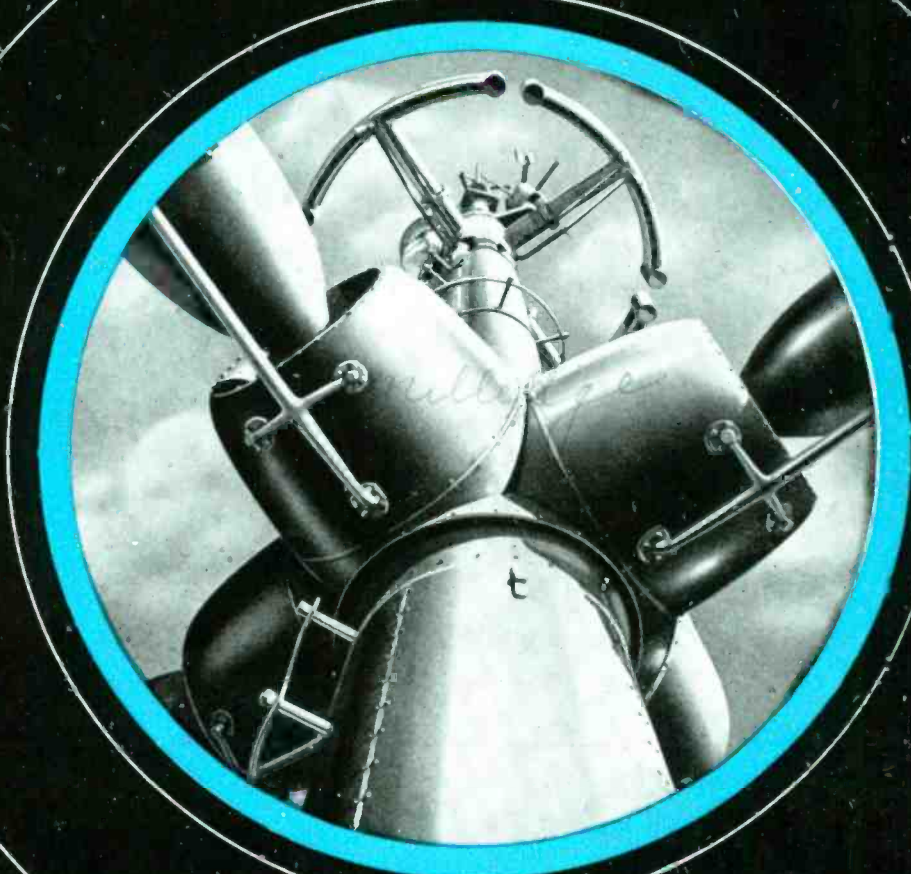

JULY 1945

1/6

Vol. LI. No. 7

IN THIS
ISSUE :

SELF-BALANCING PHASE-SPLITTING CIRCUIT

PRIMER ON RUBBER BONDING

NUMBER
12
IN SERIES

If a machine transmits vibration to a building thus . . .

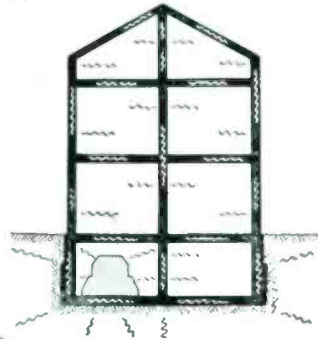

. . . the IDEAL way to prevent this transmission is to suspend the machine with springs converging on the centre of gravity thus

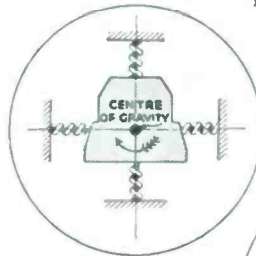

but this is the most simple compromise, using one supporting surface . . .

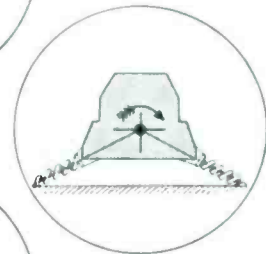

which, translated in a modern practical manner, utilizes "FLEXILANT" rubber-bonded-to-metal mountings, scientifically designed to give absorption of vibration.

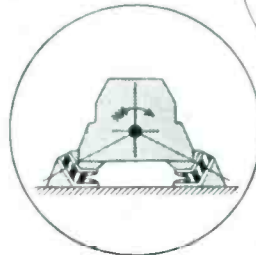

You may wonder whether a bonded product would solve your problem. We should know - if you asked us.

R 8 35



RUBBER BONDERS LTD.

ENGINEERS IN RUBBER BONDED TO METAL

FLEXILANT WORKS · DUNSTABLE · BEDS.



AVO

REGD. TRADE MARK

MODEL 7
UNIVERSAL
AVOMETER

MODEL 40
UNIVERSAL
AVOMETER

THE "AVO"
TEST
BRIDGE

THE "AVO"
VALVE TESTER

THE
ALL WAVE
"AVO" OSCILLATOR

THE world-wide use of "AVO" Electrical Testing Instruments is striking testimony to their outstanding versatility, precision and reliability. In every sphere of electrical test work, on active service and in industry, they are maintaining the "AVO" reputation for dependable accuracy, which is often used as a standard by which other instruments are judged.

Orders can only be accepted which bear a Government Contract Number and Priority Rating.

THE AUTOMATIC COIL WINDER & ELECTRICAL EQUIPMENT CO., LTD.
 WINDER HOUSE · DOUGLAS STREET · LONDON · S.W.1 TELEPHONE: VICTORIA 5404/7

LOUDSPEAKER TRANSFORMERS. Pentode Output 40:1, 50 m.a., 4/8. Midget multi-ratio 60:1, 50:1, 40 m.a., 8/8. Multi-Ratio 40:1, 60:1, 80:1 and push-pull 80 m.a., 12/6. Pentode Output 12/15 ohms, 100 m.a., 12/6. Heavy duty, multi-ratio 24:1, 41:1, 48:1, 58:1, 82:1, 118:1 and PP. 80 m.a., 15/6. 3:1 Intervalve, 10/6. Push-pull Output 20-watt, 4,000-0-4,000 Primary. 2.5, 7.5 and 19/15 ohms secondary, 25/-.

P.M. LOUDSPEAKERS. 3 ohm Voice Coll. Rola, Goodman and Celestion. 6 1/2" with transformer, 30/-; 8" with transformer, 32/6. 2 1/2", 27/6. 3 1/2", 30/-; 5", 22/6. 8", 24/-; 10" with transformer, 37/6. 12", 28/15.0. 10" Mains Energised 250 ohms, 35/-.

B.T.H. Model R.K. 10" Mains Energised Loudspeakers, 1,000 ohms field, 15 ohms speech, weight 28 lbs., re-conditioned as new. Ideal for P.A. work, 28/6.0. 10" Mains Energised, 1,140 ohms, with transformer, 45/-.

AERIAL AND OSCILLATOR COILS. Best D.S.C. wire wound, colour coded on bakelite formers. Short, Medium and Long Wave, 16/50 m. : 200/650 m. : 1,000/2,000 m. with circuit diagram, 16/- the set.

I.F. TRANSFORMERS. 465 K.C.s Iron-cored 1 1/2 watt, aluminium can. Limited quantity, 17/6 matched pair. 9/6 each.

S.M. & L. T.R.F. COILS. Philips, best quality in screened aluminium cans, 17-51, 220-555, 725-2,000 metres. (These coils equal to performance of superhet.) Complete with circuit diagram, 9/6 the set.

M. & L. T.R.F. AERIAL COILS. Aluminium screened Philips, 200-555, 725-2,000 metres, complete with circuit diagram 2/9 each.

WAVE CHANGE SWITCH to suit all above coils, 5/9 each.

SCREENED INTERLACED FLEXIBLE MICROPHONE CABLE. Twin 6 yards for 6/9. Single, 1/- per yard.

VALVES. American Types at B.O.T. controlled retail prices. For replacement purposes only. 6F5, 12F6, 12F6, 12SF5, 12H5, 9Z2; 5Y3, 10G5, 11-; 6Q7, 12Q7, 11/7; 6F5, 6K5, 6E7, 12J7, 12SJ7, 6V60 12/10; 6A8, 6B8, 6SA7, 14/-.

Also British valves at manufacturers' list prices. 6X5, 6U4, 6U6, 11/-; 6H14DD, 2DD4, 11/7; AC/VP2, 6I4, 6F39, KTW61, PEN46, 6P41, 6P42, 6A1, 6P41, 12/10. D1 Diode 1" Peanut valve, with valveholder, 12/10. ECH3, K63, 12Z3, 20Z3, 25Z4. AC8Pen, EL35, PEN 46, U21, 616, 18/8. (Include Purchase Tax, add 3d. per valve post. * Post Office permit necessary.

RADIO MECHANIC'S LONG-NOSED PLIERS. Ex-Govt. stock, reconditioned like new, exceptionally cheap, 4/-. Extra long-nosed, 8 1/2", 10/6.

RADIO MECHANIC'S SIDE CUTTERS. Ex-Govt. stock, reconditioned like new, exceptionally cheap, 4/6.

VARIABLE CONDENSERS 2-gang (small). 0005 ceramic with trimmers, fixing feet, slow-motion drive, dial frame and pointer, 17/9. 3-gang, 0005 ceramic insulation with slow motion drive, pointer and dial frame, 12/6. Midget 2-gang 00038, 10/9.

HIGH VOLTAGE BRAIDED SLEEVING. 1 and 1 1/2 mm. first-class quality, 3/6 per dozen yards. P.V.C. CABLE. 14/36, Red, Green, Blue and Yellow. 2/- per dozen yards.

WESTINGHOUSE

METAL RECTIFIERS EX-G.P.O.



Suitable for chargers, etc., H/wave H.T. 150/400 m.a., 22/6.

◆ CALLERS to Show Rooms, 2 HIGHGATE HIGH ST., N.6.

'Phone: MOUntview 9431

LINAGLOW LIMITED

2 SPECIAL KIT OFFERS

KIT 1.—Tuning heart suitable for 6-valve superhet, comprising variable condenser and slow-motion drive set of iron-cored I.F.'s 465 K.C.'s Litz wound, aerial coil, R.F. transformer and oscillator coil. All trimmers and padders with wave change switch for 3-wave bands, S.M. and L. Also circuit diagram for complete set, 23.9.6.

KIT 2. Tuning heart for 5-valve superhet, comprising variable condenser and slow-motion drive, set of iron-cored I.F.'s 465 K.C.'s Litz wound, aerial coil and oscillator coil. A litrimmers and padders with wave change switch for 3-wave bands, S.M. and L. Also circuit diagram for complete set, 22.19.6.

DE LUXE ALL-WAVE SERVICE SIGNAL GENERATOR

A.C. Mains 200/250 v. 50 cycles. Range covers from 20 M.C. to 100 K.C., all fundamentally in 5 bands without gaps. S/M Dial direct calibration in frequencies. Coarse and fine output attenuator. Internal modulation 400C/S iron-cored coils. The Generator is entirely screened in heavy metal cabinet. Dim. 10" x 10" x 12". Each 16 Gns.



SERVICE KITS

- 85.** 1 8-mfd. 400/500 v. Electrolytic. 12 each assorted tubular paper condensers, Carbon Wire End Resistors. New, ex-television. 3 yds. sleeving, 10/9.
- 86.** 1 8-mfd. 400/500 v., 1 32-mfd. 320 v. Electrolytics. 25 each assorted tubular paper condensers and carbon wire-end resistors. 1 volume control. New, ex-television. 3 yds. sleeving, 25/-.
- 87.** 2 8-mfd. 400/500 v., 1 4-mfd. 400/500 v., 1 32-mfd. 320 v. Electrolytics. 12 each assorted tubular paper condensers and carbon wire-end resistors. New, ex-television. 2 volume controls. 39/6.
- 88.** 38-mfd. 400/500 v., 3 32-mfd. 320 v., 1 8 x 8-mfd. 400/500 v. 2 4-mfd. 400/500 v. 25 each assorted tubular paper condensers, and carbon wire end resistors. 6 yds. sleeving, 6 yds. P.V.C. cable, 3 tone controls, 6 assorted valveholders. New, ex-television. 25

N.B.

Owing to depleted staff, we can only accept Cash with order. No C.O.D. Delivery 14 days.

LINAGLOW LIMITED

HOURS OF BUSINESS: Mon. to Fri. 9 a.m. to 5.30 p.m.

Nearest Tube—Archway

T.R.F. 3-WAVEBAND 4-VALVE CONSTRUCTOR'S KIT. 17-2,000 m. Parts new, ex-television. Aluminium screened coils, excellent short-wave reception (the special coils used in this circuit give a performance equal to a superhet) 4 1/2 watts output, complete with loudspeaker, all parts, wiring and theoretical diagram—nothing extra to purchase. Chassis dim.: 12in. x 8in. x 6in. to top of dial. 200/250 v. A.C., 1 1/2 gas, including tax. Case and packing, 5/- extra.

WESTINGHOUSE R.W. DETECTOR. 36 v. B.M.S. 0.25 m.a., 5/6.

MAINS TRANSFORMERS. 350-0-350 4 v. 6 amp. O.T., 4 v. 2 amp. 100 m.a. Heavy laminations, pre-war stock. Bargain, 27/6; 350-0-350 6.3 v. 3 amp. O.T. 5 v. 2 amp. 100 m.a., 32/6.

PUSH-BUTTON UNITS. Complete with escutcheon and knobs, 4-way, new, 6/-.

L.F. CHOKES. 20 henrys. 150 m.a., 16/9.

SLOW MOTION DRIVE. 8-1. Complete with drum and spindle, 3/-.

TUBULAR PAPER CONDENSERS. 350/500 v. D.C. working. New, ex-television. .0001, 3/-; .0025 4/-; .01, 6/-; .02, 7/-; .04, 8/-; .08, 9/-; .1, 10/-; .25, 12/-; .5, 21/-; per dozen. Parcel of 60 assorted, 22/8.

RELAYS. Complete with circuit breaking switch 200/250 v. A.C. 60/80 v. D.C. 300 m.a. 15-amp. switch, each 7/6.

VALVEHOLDERS. Amphenol type. International or English octal, chassis mounting, 1/- each; 10/6 per dozen. English wafer type, 4-8-pin, 6 for 2/6.

SUPERIOR QUALITY KNOBS. Ex-television. Suitable for radio, for 4in. spindles. With grub screw 1 1/2in., 1/3. 2in., 1/6. White Ivorine 1/2in. with grub screw, 9d. each.

WANDER PLUGS. In 2 colours. 3/- per doz.

LINE COILS. 3-way heavy duty, 3 amp., 360 ohms. 9/6; 480 ohms, 13/6; 600 ohms, 15/9; 2-way 360 ohms, 5/8; 480 ohms, 7/6; 600 ohms, 9/8.

VOLUME CONTROLS. 1, 5, 10, 20, 25, 50 and 100 thousand ohms. 1, 1 and 2 meg. without switch, 4/9 each. As above with switch, 6/9; 100,000 ohms, 1/2 meg., double pole switch, best American, 7/6. 2,000 ohms only, wire wound, 3/-; 1,000 ohms only, carbon, with screw, adjustment 1/6 each. Midget 1/2 meg. with switch, 7/6. Less switch, 3/6.

SPECIAL OFFER BATTERY CHARGERS. 1 amp. type, 2, 6 or 12 volt. 200/240 volt input. Finished in black metal cabinet. Small and compact. 22.19.6 each.

CAR AERIALS. Telescope scuttle fixing, extending to 4ft. 6in. Ebonite insulators, nickel plated, 22/6 each.

VIBRATORS. 4-pin, 6-volt, best quality American; 12/6 each.

BEST QUALITY Mains Toggle Switches, 1/9. Mains Switches, G.P.O. type, D.P.D.T. panel mounting 3/-. **MIDGET VANE TYPE** Vari. Trimmers, 60 mmfd., 3/-. **4-mfd. CAM CONDENSERS,** 800 v. d.c.v. 9/6. **2-mfd. TUBULAR CONDENSERS,** 350 v. 2/6. **ELECTRIC SMOOTHING IRONS.** 4 1/2 lbs., 200/250 volts. Wartime finish. Complete with lead. 22/6.

METAL RECTIFIERS EX-G.P.O.

Suitable for small chargers, relays, etc., 12 v. full wave 100 m.a., 7/6. 6 v. H/wave 50 m.a., 6/-; 4 v. H/wave 30 m.a., 5/-; 2 v. H/wave 15 m.a., 4/6. H1. 2 1/2 v., D.C., 10 m.a., 3/6.



◆ POST ORDERS to Dept. M.O.44,

61 HIGHGATE HIGH STREET, N.6.

'Phone: MOUntview 9432

WALTER CONDENSERS ARE MADE FOR



WALTER INSTRUMENTS, LTD.

Earls Court Exhibition Buildings, Earls Court, London, S.W. 5

FULHAM 6192

C. R. C 78



It isn't Isn't what!
Isn't a watt!

It's the c.g.s. unit of energy.

WHAT'S "ERG"?

ERG is the trade mark identifying a line of products that will be available when we've finished the biggest job of all.

ERG RESISTORS LTD.

1021a, FINCHLEY ROAD, LONDON, N.W.11

PHONE: SPEEDWELL 6967



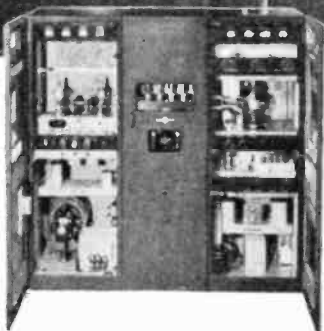
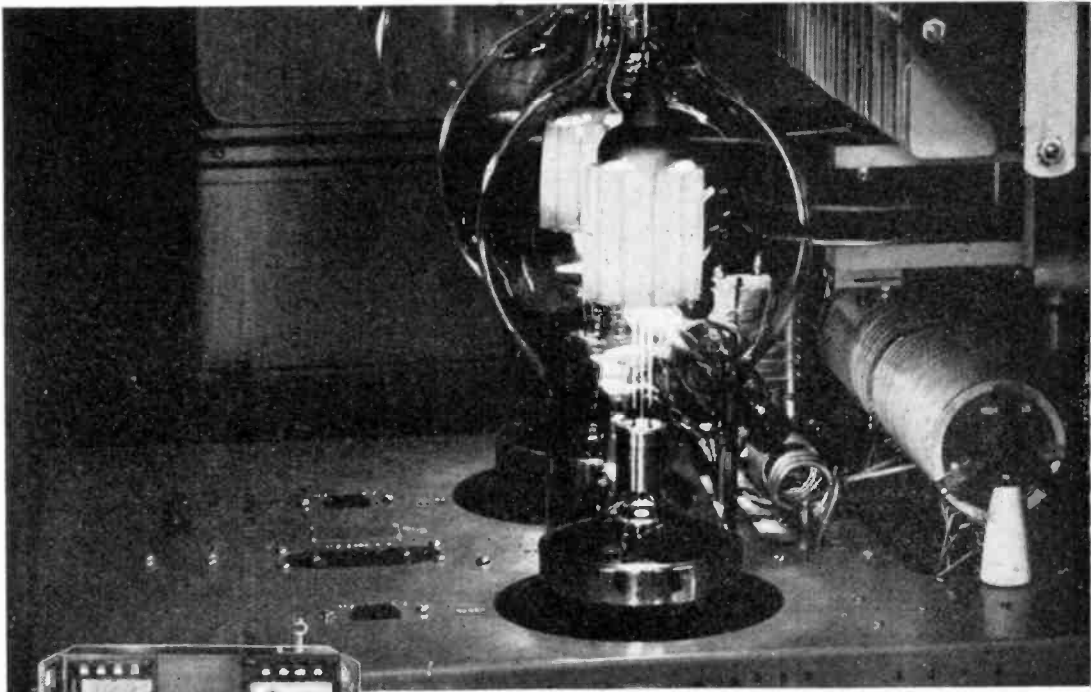

COLLINS ENGINEERING AND EIMAC VALVES *achieve outstanding results*

This Collins type 231D-11 (Navy TDH) radio transmitter is an outstanding demonstration of the value of capable engineering coupled with the intelligent choice and use of vacuum valves.

It is the latest of a series of Collins Autotune, quick shift transmitters which were originally introduced in 1939, and which use Eimac valves in the important sockets. In the 231D-11, two Eimac 750TL valves in parallel make up the power amplifier, while a pair of Eimac 450TL valves in class "B" are used as modulators for voice and MCW emission.

Mr. F. M. Davis, General Manager of the Collins Engineering Division, says: "Eimac valves have been found to be reliable, rugged and capable of withstanding the severe overloads encountered during equipment tests, without damage." Statements like this, coming from such men as Mr. Davis, offer proof that Eimac valves are first choice of leading engineers throughout the world.

Output CW—5 KW, Output Phone—3KW 100% modulated with a pair of Eimac 450TL valves in class "B" audio; continuous coverage from 2 MC to 18.1 MC with 11 preset channels in that range and complete manual coverage throughout whole range. Capable of completely unattended remote control operation and of A1, A2 and A3 type emission. Audio characteristics plus or minus three DB from 130 to 3,500 cycles. Total harmonic distortion less than 10%. The transmitter can be terminated into a 50 to 1,200 pure resistive load at zero degrees phase angle. 70 to 850 ohm load at plus or minus 45 degrees and 100 to 600 ohms at plus or minus 60 degrees

Write for your copy of Electronic Telesis—a 64 page booklet fully illustrated—covering the fundamentals of Electronics and many of its important applications. In layman's language

Follow the leaders to



EITEL-McCULLOUGH, Inc., 956 San Mateo Ave., San Bruno, Calif.

Plants located at: San Bruno, California and Salt Lake City, Utah

Export Agents: Frazer & Hansen, 301 Clay Street, San Francisco 11, California, U. S. A.

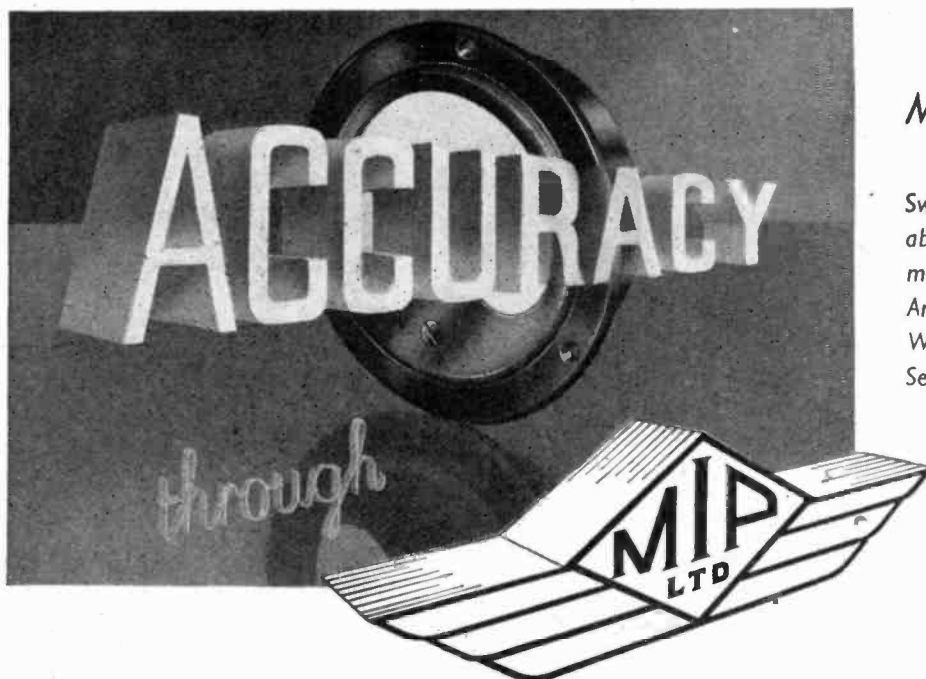

Manufacturers of

Switchboard and Portable Pattern Microammeters : Milliammeters : Ammeters : Voltmeters : Wattmeters and Testing Sets.

MEASURING INSTRUMENTS (PULLIN) LTD.
ELECTRIN WORKS, WINCHESTER STREET, ACTON, W.3.

Listen to the 
Stentorian
S P E A K E R S

a good job we're soon returning

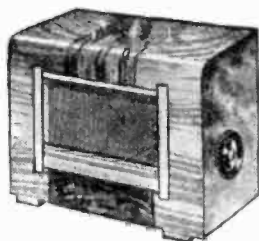

a very good job

WHITELEY ELECTRICAL RADIO CO. LTD. • MANSFIELD • NOTTS

MINIATURE or MIDGET



Originators, designers & manufacturers of Midget Valves

BRITISH

MADE

HIVAC LIMITED, Greenhill Crescent, Harrow on the Hill, Middx. Phone: **HARROW 0895**

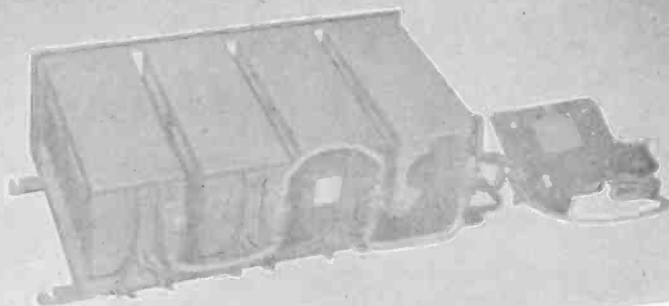

RADIO PRODUCTS

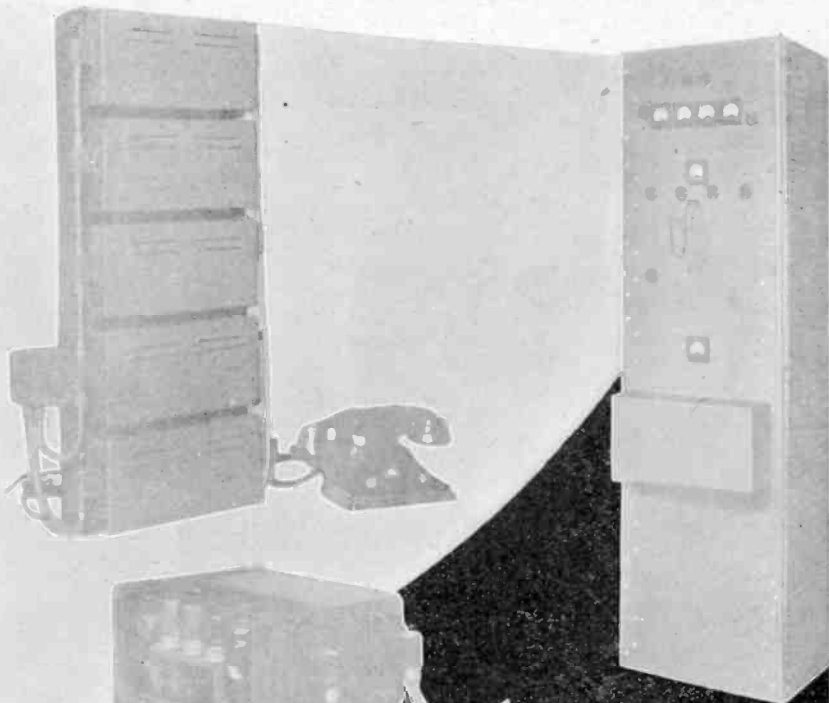
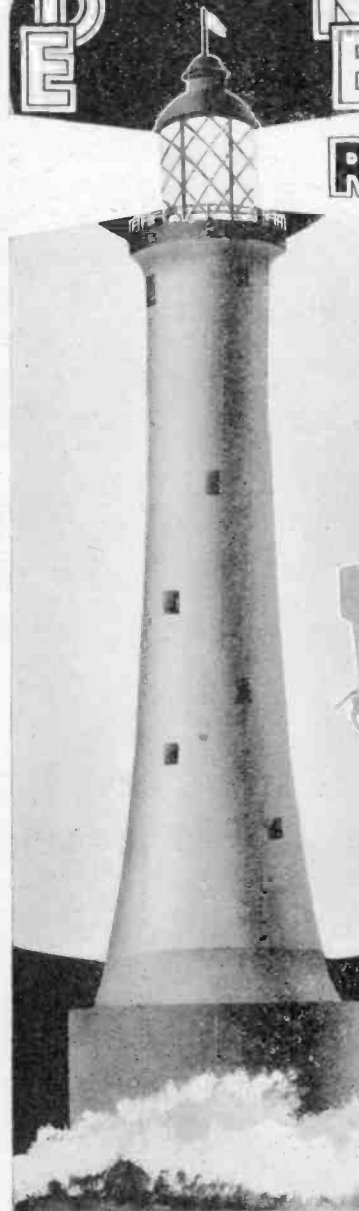

ONLY AVAILABLE
AGAINST PRIORITY

Manufactured by
STRATTON & CO., LTD., EDDYSTONE WORKS
BIRMINGHAM. Tele: PRIORITY 2231 Cables: STRATNOID BIRM

London Agents

WEBB'S RADIO, 14 SOHO STREET,
LONDON W.1. Tele: GERard: 2089

Production simplified

Solve Your Assembly Problems

with Lasso pressure sensitive adhesive tape. Printed with legible inscriptions spaced at regular intervals to suit the particular cable, pipe diameter, or size of component on to which it is to be applied. Supplied in various colours to B.S.C. Specification. Particularly suitable for pre-assembly where unskilled labour is used. Enables parts to be instantly identified.

★ *Durable, indelible, waterproof, fluid resistant, heat resistant, fix at any point, suitable for pre-assembly or after installation of components.*



Supplies of Lasso Tape are available only for high priority work owing to restrictions on raw materials.

CABLE ASSEMBLIES LTD. (Subsidiary of Herts Pharmaceuticals Ltd.) BESSEMER ROAD, WELWYN GARDEN CITY

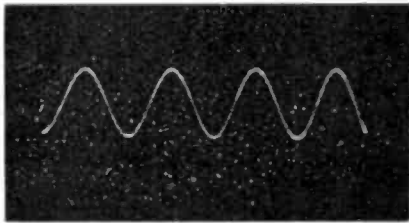

B.S.R. STANDARD SINE WAVE SOURCES TYPE LO.800A. OSCILLATOR

—an actual oscillogram of output voltage is illustrated—gives good waveform even below 10 c.p.s. This necessitates a minimum "pull-in" between the two H.F. oscillators. Superlative design results in an almost perfect waveform from the lowest to highest frequencies. The output voltage is constant to within a few per cent. over the frequency range. This Model is chosen as a Standard by most Departments. Stable, reliable. Indispensable to all serious workers.

Output up to 5 watts. Three range output voltmeter incorporated—0-250, 0-50, 0-10. Four output impedances, 5000, 1000, 600 and 15 ohms. Frequency ranges (3 models), 0-15000, 0-25000 and 0-50000 c.p.s.

**BIRMINGHAM SOUND
REPRODUCERS LTD.**
Claremont Works, Old Hill, Staffs.
Oxley Heath 9212/3. Gramos: Electrocoke, Old Hill



Sales Concessionaires:

HOLSUN BATTERIES LIMITED, 137 Victoria St., London, S.W.1



URGENT! SAID THE G.P.O.

So Mazda Valves helped to break a bottleneck in submarine cable traffic

Beneath the Irish Sea lies a telephone cable that now carries double its peak load.

The British Post Office answered the urgent demand for greater inter-country communications by introducing a submerged Repeater into the cable which increased its simultaneous telephone circuit from 24 to 48.

Weighing nearly a ton, this repeater must give absolutely reliable service under these exacting conditions year in and year out, because to lift it from the sea-bed is a major and expensive operation.

Standard Mazda SP.41 valves were chosen for this amplifier following ageing tests on numerous different types. Checked again after 11,000 hours continuous operation, the valves were found as serviceable as ever.

Mazda are proud of their contribution to this great development in submarine cable facilities—proud of the proved reliability of their standard valve. This is but one instance of the reliable service Mazda valves are giving in many spheres where technical discoveries are hastening the birth of a new age.

MAZDA valves

FOR INDUSTRIAL, MEDICAL, RADIO, SCIENTIFIC,
TELEPHONIC AND DOMESTIC APPLICATIONS



THE EDISON SWAN ELECTRIC CO., LTD.,
155 CHARING CROSS RD., LONDON, W.C.2.



To the Services
and those who
backed the
Services —
Our grateful thanks

GOODMANS
Industries Ltd.

GOODMANS INDUSTRIES LTD · LANCELOT RD · WEMELEY · MIDDX
G.D.I.

The
TAYLOR A.C. BRIDGE
MODEL 110A

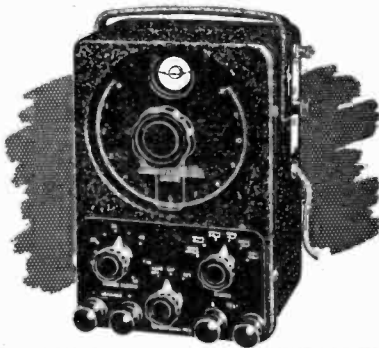

6 RANGES OF CAPACITY
RANGES OF RESISTANCE

The six Capacity ranges cover from .00001 to 120 mfd. and the six Resistance ranges from 1 ohm to 12 Megohms. Power factor can be measured on all Capacity ranges. Please write for technical leaflet.

Price £14 14s. 0d.

Taylor
electrical instruments

Send enquiries to :—
TAYLOR ELECTRICAL INSTRUMENTS LTD
419-424 Montrose Avenue, Slough, Bucks.
Tel.: Slough 21381 (4 lines) Grams: "Taylins", Slough

For
Reliability

Trust
TRIX

Quality **SOUND** Equipment

THERE ARE TRIX AMPLIFIERS FROM 5 to 500 WATTS FOR PRIORITY WORK

THE TRIX ELECTRICAL CO. LTD.
1-5, MAPLE PLACE, TOTTENHAM CT. RD.
LONDON, W. 1.
Tel: MUSEUM 5 817 Grams / Cables, TRIXADIO, WESDO, LONDON.

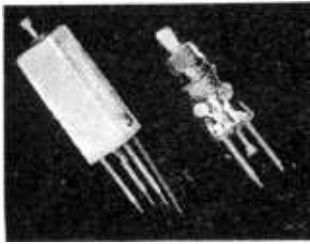

WORLD'S LARGEST RADIO COIL MANUFACTURERS

- RADIO FREQUENCY INDUCTORS
- INTERMEDIATE FREQUENCY TRANSFORMERS
- RADIO FREQUENCY COIL CHOKES
- MICA COMPRESSION CONDENSERS
- AIR DIELECTRIC CONDENSERS
- MICA MOULDED CONDENSERS
- SICKLES SILVER CAP CONDENSERS
- GANGED PERMEABILITY TUNING COMMUNICATIONS EQUIPMENT
- F.M. EQUIPMENT PARTS
- U.H.F. RADIO EQUIPMENT
- SPECIAL ELECTRONIC EQUIPMENT

The F. W. SICKLES Co.
CHICOPEE, MASS., U.S.A.



They fit inside a delicate ring, they are so small; but they are mighty in dependable performance for hearing aid apparatus. Long lived with low battery drain, RAYTHEON Flat hearing aid tubes give quality performance for electronic hearing aids.



RAYTHEON PRODUCTION CORPORATION
HEARING AID TUBE DIVISION
Newton, Massachusetts.



ARMY-NAVY "E" WITH STARS
Awarded all four Divisions of Raytheon for Continued Excellence in Production.

P. R. MALLORY & CO. Inc.
MALLORY VIBRATORS
ARE ALWAYS DEPENDABLE

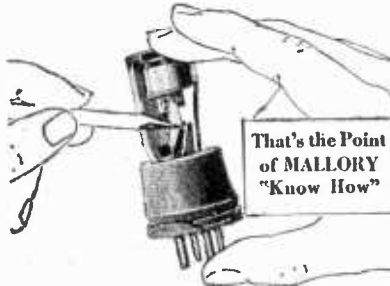

Contacts in a vibrator take a lot of punishment. They must operate under widely varying conditions of temperature and must "make and break" 115 times a second. Small wonder that alert engineers think of contacts first when selecting a vibrator!

For over 20 years, Mallory has been Industrial headquarters for every type of electrical contact. It has introduced new contact compositions... evolved better designs... formulated improved surface finishes.

As a result of this wide experience, Mallory equips its vibrators with special grade tungsten contacts which are cut in its own plant from material made to its own specifications. They give longer life, are subject to a minimum of erosion and transfer.

Mallory is ready to apply its special vibrator "know how" to your specific applications.

P. R. MALLORY & CO. INC.
INDIANAPOLIS, INDIANA,
U.S.A.

Radio and Electronics Division

ALSO
"MYKROY" CERAMIC INSULATING MATERIALS
GENERAL ELECTRONIC VACUUM CONDENSERS

FOR THE FUTURE

These Manufacturers will help solve your post-war problems.

Register your name now for full details which will be sent you when supply conditions again permit.

FRANK HEAVER

LIMITED

Kingsley Road, BIDEFORD,
N. Devon



VICTORY PRODUCTION

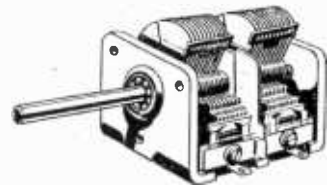

TYPE 2600 MIDGET VARIABLE CONDENSER

WHEN the mission of complete victory is accomplished, General Instrument will help "Win the Peace" by making the best use of still greater knowledge and experience in the manufacture of variable condensers and drives.

THE GENERAL INSTRUMENT CORPORATION

ELIZABETH, N.J., U.S.A.



TWO-WAY radio communication systems, like the plastic-cased beauty illustrated,

are one of the new developments leading industrial designers are thinking of to speed the work of a busy post-war world. Applications of this compact, plastic-cased 'walkie-talkie' are almost unlimited. Naturally, this is only one of thousands of uses plastics will be put to after the war, but it will serve to remind you that post-war planning is being done... Kurz-Kasch designers, engineers, tool-makers and moulders... specialists for a generation in plastic planning and moulding will help you with your problems.



KURZ-KASCH INC.
Planners and Moulders for the Age of Plastics
DAYTON · OHIO · U.S.A.

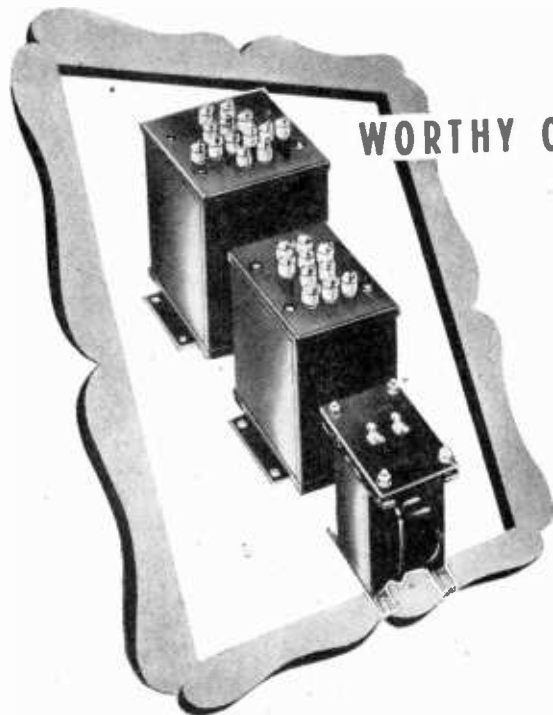

WORTHY OF THE FINEST SETTING

Some of the finest electronic equipment produced in recent years and operating under the most arduous conditions embody Gardner Transformers and Chokes exclusively, a setting of which they have proved well worthy. Not so remarkable when their quality, design and performance are considered in their true perspective. Naturally then, the whole of our production is earmarked for work of the highest priority.

GARDNERS
RADIO LIMITED

SOMERFORD · CHRISTCHURCH · HANTS

WHY YOU PREFER ACOUSTICAL—One of a series

A new
LOW DISTORTION
OUTPUT CIRCUIT

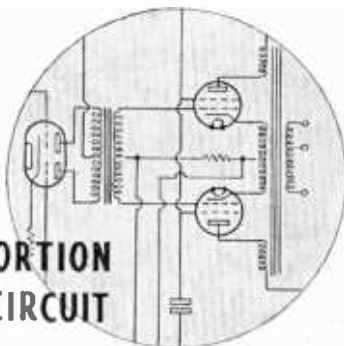

The new low distortion output circuit (an Acoustical Provisional Patent) incorporated in the M31 Amplifier provides a very high standard of reproduction—The output valves operate partly as triodes with cathode follower output and partly as tetrodes with negative feedback, thus giving considerable cancellation of generated harmonics and a high damping factor. Just one reason why you prefer Acoustical.

"Addressing the Public"—a booklet of useful information and diagrams for all those engaged on Public Address work. 1/- post free.



M.R. SUPPLIES

have the following superior and brand new RADIO and ELECTRICAL EQUIPMENT in stock and available for immediate despatch or collection. All prices net cash. **VOLTAGE CHANGING TRANSFORMERS**, 200/250 v. to 100/110 v. (and vice-versa). Fully shielded, with countersunk terminal blocks and properly rated. 75 va., 22/6. 120 va., 37/6. Also small supply of 550 va. (suitable for cine, electro-medical, etc.). Double-wound, 230 v. to 100 and 110 v. (and vice-versa), in cast brackets with terminal panels, 26 1/2s. (owing to heavy weight and packing difficulties we cannot despatch the 550 va. model—we have 72 only).

STEP-DOWN TRANSFORMERS, 200/250 v. Prim. Secs.—5, 12 and 17 v. at 6 amps., 49/6 (desp. 2/-). Secs.—7, 11 and 15 v. at 2 amps., 20/- Sec.—22 v. at 2 amps., 18/6.

BATTERY CHARGERS, for 200/250 v. A.C. Metal rectified. In strong black crystal-line steel cabinet, 9in. x 5in. x 4in. for wall suspension. Screw-in mains despatch and radial switch for voltage selection, 2, 6 and 12 v., at full 1 amp., 23 17s. 6d.

S.T.C. METAL RECTIFIERS, D.O. delivery up to 12 v. at 1 1/2 amps., 12/6. **SLIDING RESISTANCES**, 100 watts. Fully enclosed, constantly rated. 10 ohms 3 amps., 50 ohms 1.4 amp., 200 ohms 0.7 amp. Any one, 25/- Also 172 ohms (graded). Max. 2 amps.; min. 0.07 amp., 32/6. **STAGE DIMMERS**, controlling stated load from full bright to black-out at 220/240 v., fitted worm drive and handwheel, 1,000 watts, 26 17s. 6d. 1,500 watts, 28 8s. (Carr. either 7/6, plus 20/- for returnable case).

MILLIAMMETERS by first-class makers. High-grade precision m/coil instruments, flush mg. 0/1 m.a., 2 1/2in., 52/6; 3 1/2in., 67/6. Also same make, 0/500 microamps (for 2,000 ohms/volt combined instrument), 3 1/2in., 75/- **VITAVOX HIGH FIDELITY SPEAKERS**, 12-in. P.M. (Ticonal), 16 ohms coil, handling 10 watts. Very latest development and best specification. 27 (desp. 5/-). We are obtaining maximum delivery of these but have to advise early application.

GOODMAN MINIATURE P.M. M/COIL UNITS, for speaker or microphone. 3 1/2in. overall, fitted high-Gux P.M. latest model, 30/-.

GRAMPIAN M/COIL MICROPHONES, suspended in square frame with plated mounting boss, 15 ohms, 24 4s. Also same make, Senior model for highest quality work, all plated with local on-off sw., 15 ohms, 27 5s. **ROTHERMEL PIEZO-CRYSTAL MICROPHONES**, D.104, all-plated with suspension rings and 6ft. sc. cable, 25 5s. Also sound coil type BR 26, 210 10s. Also miniature dead-aid insert type, 1 1/2in. dia., 22/6. **FLOOR STANDS**, collapse. ext. to 5 1/2ft., all chrom., 45/6. Cradles for D.104 only, 8/-.

G.E.C. PROJECTOR SPEAKERS for efficient P.A., supplied with 10-watt P.M. weatherproof unit, 15 ohms (with 600 ohm line trans.). With 42in. all-metal exp-horn, 210 5s. (carr. 7/6) and with 30in. Triple Horn (dial for car use), 210 15s. (ex this address). Single 30in. metal HORNs, fitted standard thread, 47/6 (carr. 3/-).

G.E.C. INDUSTRIAL SPEAKERS, in 12in. drum, handling 8 watts, fitted multi-trans., 65/- (carr. 3/-). **ERIKSSON HEADPHONES**, with adjustable headgear, 2,000 ohms, 25/- pair. **PYROBT ELECTRIC WELDING IRONS**, only model that can be held like a pencil, 9in. long, best for elect. work, 220/250 v., 23/- **RESTS** for same, with cleaning die, 4/- **SPARE ELEMENTS**, 3/6 **SPARE ANGLE BITS**, 4/6 **CENTRALAB VOL. CONTROLS**, less switch, 1,000, 3,000, 10,000, 50,000, 100,000 ohms and 1 megohm, any one, 3/11 (4 1/2/- doz.). **PYROBT NYON TESTERS**, with screwdriver, 100/750 v., 9/6. **ROTHERMEL CRYSTAL PICKUPS**, senior bakelite model, 78/6. **STROBOSCOPIC SPEED TESTERS**, (50 c.) showing 78, 79 and 80 r.p.m. (cardboard only), 1/-.

Please include sufficient for despatch, where not stated.

M.R. SUPPLIES, 68, New Oxford Street, London, W.C.1

(Telephone: MLU 6000 2958)

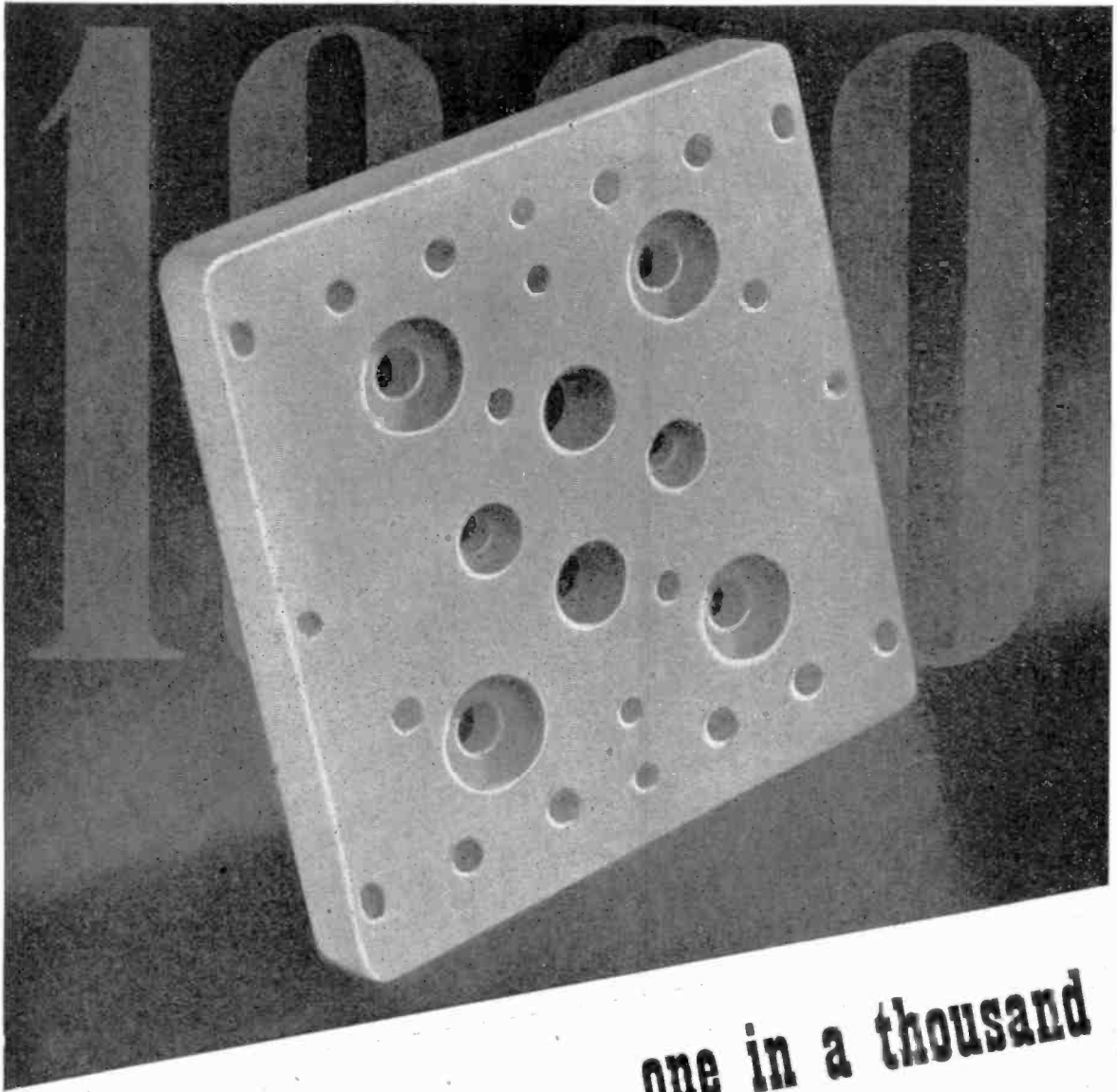

one in a thousand

Ten years ago we introduced the first British-made low-loss ceramic. To-day the range of **Frequentite** components covers more than a thousand pieces of every shape and size.

With such a store of manufacturing experience we are able to offer advice backed by practical knowledge on your insulation problem. Please consult us before you finalize your design.



STEATITE & PORCELAIN PRODUCTS LTD.

Head Office: Stourport-on-Severn, Worcs.

Telephone: Stourport 111.

Telegrams: 'Steafin, Stourport.

L.P. 37

A COMPACT AND PRECISE WAVEMETER FOR USE IN ALL CLIMATES

EVERY ship and shore radio station must have, as an essential part of its equipment, a wavemeter that is absolutely reliable under all conditions.

The Rediffusion 605A Wavemeter has been constructed to have a discrimination of 0.1 per

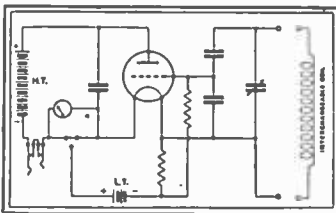

CIRCUIT OF THE REDIFFUSION
605A WAVEMETER

cent over a range of frequencies from 100 to 43,000 kilocycles (3,000 to 7 meters). This range is covered by using 8 coils, which are carried in a separate case and are

used in conjunction with a graph card made out for each individual coil. Tuning is by means of a variable condenser.

The 605A Wavemeter is normally used for frequency measurement of a transmitting station, and as a standard by which to tune a transmitter output. It can also be used to indicate the resonance of modulated carrier waves, and to indicate the functioning of a very low-power radiating circuit.

The wavemeter unit is light and compact, weighing only $7\frac{1}{2}$ pounds, and is 5" x 8" x 8". The construction throughout has been designed to resist severe variations of climate in most parts of the world. The eight coils are carried in a case of similar size weighing 4 pounds. In use the coils are attached to two terminals placed on the side of the wavemeter.

This instrument is available now. Further details can be sent on request.

REDIFFUSION Ltd.

Designers and Manufacturers of Radio Communication
and Industrial Electronic Equipment

SUBSIDIARY OF BROADCAST RELAY SERVICE LIMITED

VICTORIA STATION HOUSE, LONDON, S. W.1 (Phone Victoria 8831)

CELESTION

VALVEHOLDERS LOUDSPEAKERS

Celestion Limited
Kingston-upon-Thames
Telephone: KINGSTON 5656-7-8

INSTRUMENTS
OF UTMOST PRECISION



20
YEARS
SPECIALISED
EXPERIENCE

MODERN DESIGN,
HIGH-GRADE ROBUST
MOVEMENT, CONSTANT
ACCURACY UNDER ALL
CONDITIONS OF USE.

SIFAM

INSTRUMENT CO. LTD.
DEVON.

ELECTRONICS



Many Osram valves now on the secret list will be available, when priority ceases, to meet the needs of electronic designers in every sphere.

made it possible!

Hullo, Red Section, tanks at 9 o'clock—follow me—

and as one well-knit unit the flight goes hurtling down to its target, tied together with an invisible electronic link. Close command in the air depends on radio communications, and at the heart lies the electronic valve.

OSRAM VALVES have been in the forefront of electronic development during the war, and will bring to the pursuits of peace many well-tried electronic devices to speed, smooth and make safer our way of life.

Osram
PHOTO CELLS

S.E.C.
CATHODE RAY TUBES

Osram
Valves



Clear as a
Crystal

AND HERE IS THE REASON . . .

. . . the answer has been found in Bullers Low Loss Ceramics to the problem of Dielectric Loss in High Frequency circuits.

Years of Laboratory research and development have brought these materials to a high degree of efficiency. To-day they are in constant use for transmission and reception, and play a vital part in maintaining communications under all conditions.



Made in
Three
Principal
Materials

FREQUELEX

An Insulating material of Low Dielectric Loss, for Coil Formers, Aerial Insulators, Valve Holders, etc.

PERMALEX

A High Permittivity Material. For the construction of Condensers of the smallest possible dimensions.

TEMPLEX

A Condenser material of medium permittivity. For the construction of Condensers having a constant capacity at all temperatures.

BULLERS, LTD.
THE HALL,
OATLANDS DRIVE,
WEYBRIDGE, SURREY

Telephone :
Walton-on-Thames 2451
Manchester Office :
196, Deansgate, Manchester.

Bullers

LOW LOSS CERAMICS

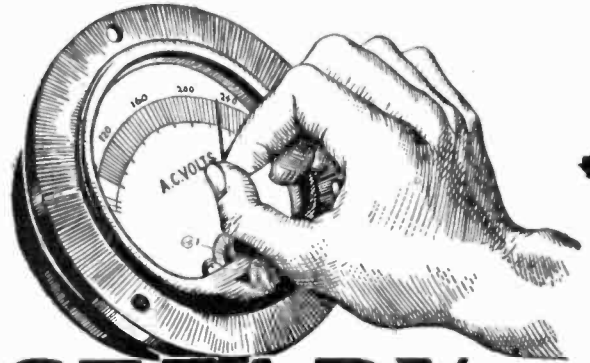

STEADY

your A.C. SUPPLY WITH A

WESTINGHOUSE

STABILISTOR

the only constant voltage equipment giving a constant UNDISTORTED output with changes in mains voltage and load.

Write for literature to Dept. W.W.

WESTINGHOUSE BRAKE & SIGNAL CO. LTD.,
Pew Hill House, Chippenham, Wilts.

Even a double load doesn't shorten the life of a
Welwyn Resistor

"No property of the resistance presented any apparent alteration." Such is the independent report after testing a Welwyn Vitreous Resistor for 870 hours at continuous double load. (Normal load gives working temperature of 450°C.)
Sizes:—1 w. to 300 w.

New Trade catalogue available.
WELWYN ELECTRICAL LABS. LTD
Welwyn Garden City, Herts. Pho: Wel. Gar. 3818

CLIX

B.9.G.
VALVE HOLDER

Meeting all requirements of latest specifications.

Polystyrene VH359/9. Ceramic 369/9.

BRITISH MECHANICAL PRODUCTIONS LTD.

1, Church Road, Leatherhead, Surrey. Tel.: 3062.

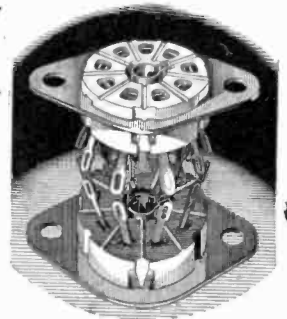

Exide

IN PARLIAMENT

In the House of Commons :

Mr. EVELYN WALKDEN asked the President of the Board of Trade why 120-volt Exide Batteries which are sold at 11s. 1d. are in short supply and other 120-volt batteries of less reliable make, and sold at 15s. 6d., only are available . . .

Mr. DALTON : Wireless batteries are now in short supply, owing to the heavy demands of the Services, and it is necessary, therefore, to make use of the output, although small, of the higher cost producers. Prices are controlled under the Price of Goods Act, 1939, and those charged for both classes of battery referred to by my Hon. Friend have been investigated and approved by the Central Price Regulation Committee.

Mr. WALKDEN : While appreciating what my Right Hon. Friend has said, is he not aware that batteries are used largely by people in small homesteads who cannot understand why good batteries cannot be obtained while there is a plentiful supply of inferior ones. . . ?

Mr. DALTON : I am very anxious to get a fair distribution of whatever supplies there are, but the best batteries are required for the Services in a very great and increasing quantity . . .

(Extracts from Hansard, Jan. 16)

THE CHLORIDE ELECTRICAL STORAGE COMPANY LIMITED

GROSVENOR GARDENS HOUSE · LONDON · SW1

B.I. CAPACITORS



for arduous conditions

B.I. Tropical Type Paper Capacitors in Moulded Tubes, (U.K. Patent Nos. 506024 and 557503) are designed to operate continuously in extremely arduous conditions of temperature and humidity.

BRITISH INSULATED CABLES LTD.
Head Office: PRESCOT - LANCs. Tel. No. PRESCOT 6571

RAYMART COILS

RD4 low-loss dielectric material is used exclusively in "Raymart" coils.

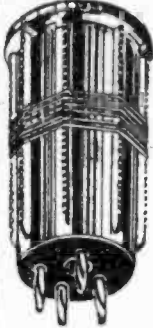

4-Pin			Price
Type CA.	11 to 25 metres	...	2/6
" CB.	20 to 45 "	...	2/6
" CC.	44 to 100 "	...	2/9
" CD.	80 to 180 "	...	2/9

6-Pin			Price
Type CA6.	11 to 25 metres	...	2/9
" CB6.	20 to 45 "	...	2/9
" CC6.	44 to 100 "	...	3/-
" CD6.	80 to 180 "	...	3/-
" CE6.	110 to 250 "	...	3/3

RAYMART COIL FORMERS
4, 6 and 7-pin are also available. Full details on request.

RAYMART MICRO-VARIABLE CONDENSERS
Models available: Standard (VCX); Midget (MCX) Series Condensers, etc. Further details and prices supplied on application.

Please include postage on orders under 5/- in value.

RAYMART

CRAFT A CREED

48 HOLLOWAY HEAD, BIRMINGHAM, 1
Telephone: Midland 3254



5 mmf/ft

NEW LOW LEVELS in capacity and attenuation of CO-AX Cables mean new possibilities in electronic equipment design both for the war effort and for the post-war electronic age.

Write for characteristics

BASICALLY BETTER AIR-SPACED

CO-AX LOW LOSS CABLES

TRANSRADIO LTD. 16 THE HIGHWAY - BEACONSFIELD - 4-BUCKS.

Varley

THERMAL DELAY SWITCHES

★ PROTECT YOUR RADIO EQUIPMENT ★

4 VOLT · 5 VOLT or 6.3 VOLT HEATERS

OLIVER PELL CONTROL LTD
CAMBRIDGE ROW · WOOLWICH · S.E.18
TELEPHONE: WOOLWICH · 1422

Superspeed

SPECIAL

CORED SOLDER

A.I.D. APPROVED

H. J. ENTHOVEN & SONS LTD.
230 THORNTON ROAD, WEST CROYDON, SURREY
THORNTON Heath 2462

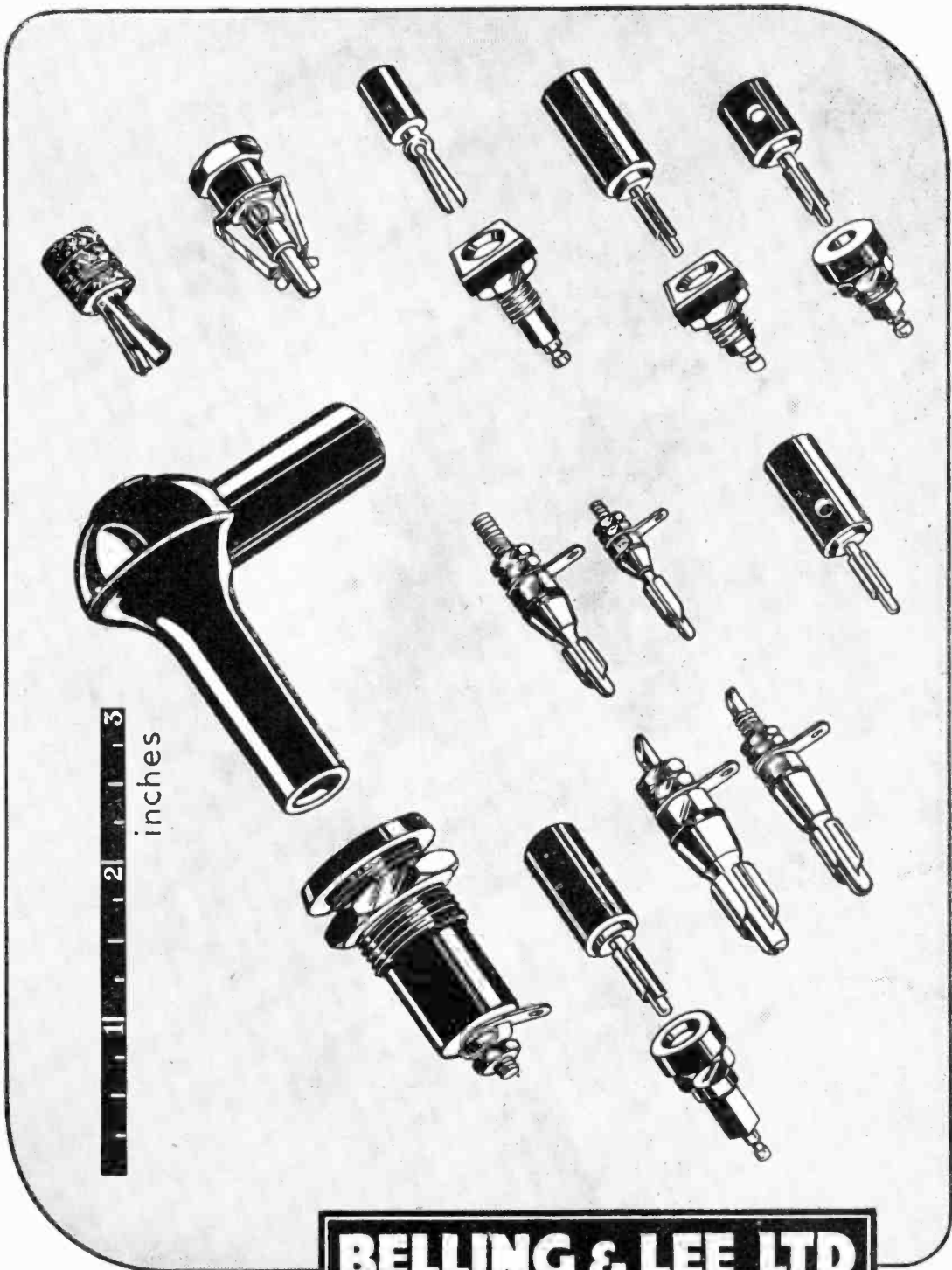

BELLING & LEE LTD
CAMBRIDGE ARTERIAL ROAD, ENFIELD, MIDDX.

GA

B



A Spire assembly is a tight assembly — and nobody need trouble to send us any jokes about the word 'tight'. It's no joke fumbling and fitting washers and nuts on to invisible bolts. It's no joke knowing that the things will probably shake loose anyway inside a few weeks. If you use a Spire fixing these worries disappear along with the nuts and washers. There are a few thousand firms making motor vehicles and radio sets and hundreds of other products who know that for light assembly Spire means strength. If you don't know but would care to find out, send us your drawings or the parts of an assembly. We'll see what Spire can do and let you have the answer in a couple of weeks — more or less.



— **THAT'S Fixed THAT!** —

Here's a Spire Nut of the U type that is doing noble work for electrical manufacturers concerned with cable assembly. The NU 1381 replaces the normal nut and washer used for holding the cable clips on perforated cable trays. The U fixing makes such blind assembly easy. The Spire Nut slips into position gripping the tray and there it is, ready — no more fumbling about with a nut that you can't see.

Spire
* **A BETTER way of fixing**

Wireless World

Radio and Electronics

35th YEAR OF PUBLICATION

JULY 1945

Proprietors :
ILIFFE & SONS LTD.

Managing Editor :
HUGH S. POCOCK,
M.I.E.E.

Editor :
H. F. SMITH

Editorial, Advertising
and Publishing Offices:

DORSET HOUSE,
STAMFORD STREET,
LONDON, S.E.1.

Telephone :
Waterloo 3333 (35 lines).

Telegrams :
"Ethaworld, Sedist, London."



PUBLISHED
MONTHLY

Price : 1/6

(Publication date 26th
of preceding month)

Subscription Rate:
Home and Abroad
20/- per annum.

MONTHLY COMMENTARY	193
THE SEE-SAW CIRCUIT. By Sqdn. Ldr. M. G. Scroggie	194
HIGH-SPEED RADIO-TELEGRAPHY RADIO PROSPECTS. By H. A. Hartley	197
DISTORTION IN AF TRANSFORMERS. By Thomas Roddam	199
WRITING TEXTBOOKS. By A. U. Thor	202
SYNTHETIC TRAINING FOR AIRCREWS.. " TELEVISION COMMITTEE'S REPORT "	203
By R. W. Hallows	205
" VALVE VECTORS "	207
By Dr. D. H. Parnum	209
BRITAIN'S MONITORING SERVICE RANDOM RADIATIONS. By "Diallist"	211
TELEPATHY. By "Radiophare"	212
By "Radiophare"	214
WORLD OF WIRELESS	217
LETTERS TO THE EDITOR	219
RECENT INVENTIONS	222
UNBIASED. By Free Grid	224

Branch Offices :

COVENTRY :
8-10, Corporation Street,
Telephone : Coventry 5210.
Telegrams :
" Autocar, Coventry."

BIRMINGHAM :
Guildhall Buildings,
Navigation Street, 2.
Telephone :
Midland 2971 (5 lines).
Telegrams :
" Autopress, Birmingham."

MANCHESTER :
260, Deansgate, 3.
Telephone :
Blackfriars 4412 (4 lines).
Telegrams :
" Iliffe, Manchester."

GLAGGOW :
26B, Renfield Street, C.2.
Telephone : Central 4857.
Telegrams : "Iliffe, Glasgow."



As many of the circuits and
apparatus described in these
pages are covered by patents,
readers are advised, before
making use of them, to satisfy
themselves that they would
not be infringing patents.

JUST TO REMIND YOU—
"HYPERLOY"
TRANSFORMERS & CHOKES

- WEIGH ONLY TWO OUNCES
- MEET THE MOST RIGID TROPICAL SPECIFICATION
- CAN EASILY BE MOUNTED IN ANY POSITION
- VARIED WINDINGS MEET MANY DIVERSE APPLICATIONS
- FULFIL THE MOST EXACTING REQUIREMENTS OF MODERN ELECTRONIC AND COMMUNICATIONS EQUIPMENT

1023

WRIGHT & WEAIRE LTD
HIGH ROAD • TOTTENHAM • LONDON • N17 Tel.: TOTTENHAM 3847/9
VIBRATORS • TRANSFORMERS • SWITCHES • COILS

MULLARD



CATHODE RAY TUBES

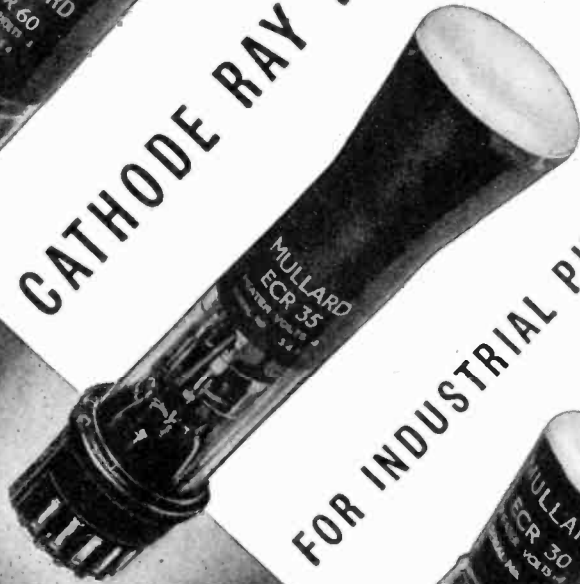

FOR INDUSTRIAL PURPOSES



TYPE	SCREEN DIAMETER	LIST PRICE
ECR. 60	6"	£7. 7. 0
ECR. 35	3½"	£6. 6. 0
ECR. 30	3"	£3. 3. 0

Wireless World

Radio and Electronics

Vol. LI. No. 7

JULY 1945

Price 1s. 6d.

Monthly Commentary

Peacetime Radiolocation

WRITING in the American journal *Electrical Engineering* for March, Captain J. B. Dow, Director of the Electronics Division of the United States Navy, makes a strong plea for the establishment of a radiolocation patents pool. It is contended that, without some such arrangement, the application of radiolocation to peacetime purposes may be seriously delayed. According to Capt. Dow, 95 per cent. of U.S. radiolocation patent applications are subsequent to January 1st, 1941, and, as most of these are at present secret, it would take a long time to clarify the patent position. He estimates the probable volume of sales of equipment for Government and commercial radar in the U.S. as amounting to \$75 millions a year for several years to come, and contends that, if the public is to have the full benefit of the best equipment that can be devised in the existing state of the art, constant litigation and the "pyramiding of royalty rates" must be avoided. Another point is that practically all development of radiolocation has resulted directly or indirectly from the expenditure of public funds, so the U.S. Government would hardly tolerate the continued payment of excessive royalties.

Much of what Capt. Dow says would apply with equal or even greater force in this country, and it seems quite probable that something on the lines he proposes may well be of benefit to us here. Peacetime radiolocation cannot get off the starting mark too quickly, and it is worth while examining in some detail any proposals that show promise of bringing about that object.

The suggested American pool is envisaged as an organisation of the industry, possibly financed initially by a Government loan, with membership limited to firms or individuals contributing patents essential to the operation of the pool. It would, of course, grant sub-licences, and the proceeds from these licences would be distributed to each pool member in proportion to the value of the patents that he contributes. A uniform royalty of 6 per cent. of the selling price of radar equipment

should be paid by all licensees. It is thought that the pool should have a life of ten years.

So much for Capt. Dow's proposals as they affect the American domestic position. On the international aspects of the matter he says little beyond making the proposal that "Foreign holders of United States patents essential to radar, of which there may be a considerable number, should also be admitted to membership of the pool corporation under conditions to be determined."

During the war, knowledge on radiolocation has been freely shared between ourselves and our American Allies and we submit that an extension of the same principle—with appropriate modifications—may well be of benefit to both of us in peacetime. An Anglo-American pool should not be beyond the bounds of possibility, and its existence should do much to smooth away the obstacles standing in the way of the future development of radiolocation for peacetime uses.



Circuit Diagrams

NOW that the revision of standardised graphical symbols for use in circuit diagrams is under discussion, we think that attention should be drawn to a matter that seems too often to be ignored. The circuit diagram is essentially a medium for illustrating circuit principles and not practical details. It should show those principles in the clearest and simplest way possible, without all those complicating details that belong properly to a "practical wiring plan"—quite a different thing. It is unnecessary, or even positively harmful, to waste time in devising a host of symbols for, say, illustrating physical differences between various types of components of the same class. Practical details are generally best shown with the help of reference letters or numbers in the text accompanying the circuit diagram. Equally, it should be unnecessary for us to burden our memories with a multiplicity of standardised symbols representing little-used auxiliary appliances, not fundamental to the working of the circuit.

THE SEE-SAW CIRCUIT

A Self-balancing Phase-Splitter

By SQDN: LDR. M. G. SCROGGIE

THE phase-splitter circuit shown in the February, 1945, issue (p. 38) is an interesting alternative to the several better-known types; but as the primary purpose of the diagram was to illustrate some notes on new Dutch valves—in particular a triode-hexode, which type is not essential to the circuit—the layout tended to obscure the basic principle of the phase-splitter. It may therefore be helpful to redraw the circuit in its simplest form as in Fig. 1, using (for the benefit of any who care to make a comparison) the same component numbers as in the original.

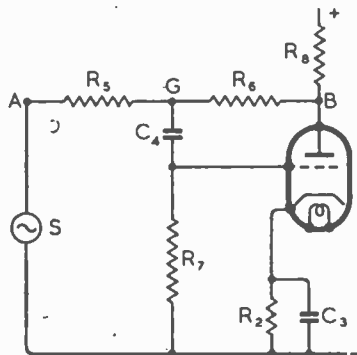

Fig. 1. The see-saw circuit in its simplest form.

A and B are the two points from which are obtained the two anti-phase voltages for driving the push-pull output stage. S is the source of the signal (in practice, almost invariably the output of an amplifier valve), and is itself the drive for one of the push-pull valves. The problem is to provide a second drive, equal in voltage, but opposite in phase.

In the well-known paraphase system, the connections are the same as in Fig. 1 except that R_6 goes to a point of fixed potential (+ or -) instead of to B. R_5 and R_6 then together form a potential divider which is adjusted to step down the voltage at A in the same ratio that the

valve steps it up. For example, if the voltage amplification of the valve is $\times 40$, the tapping is adjusted to make R_5 39 times as great as R_6 , so that the voltage applied to the grid of the valve is $1/40$ th of that at A, and the voltage at B equals that at A. The valve provides the necessary phase reversal, and its voltage multiplication exactly offsets the voltage division between A and its input. At least, it is when the tapping is exactly adjusted.

And that is one of the disadvantages of the paraphase method. For it is clear that a very slight shift of the knob controlling the tapping point may cause the voltage at B to become seriously unequal to that at A. A change in the amplification of the valve likewise upsets the balance. It is perhaps not unduly idealistic to aim at a balance in which one output voltage does not differ from the other by more than about 10 per cent. Without instruments of some kind it is not easy to readjust the balance.

Now consider Fig. 1, in which R_5 and R_6 are equal high resistances—of the order of 1 megohm. The easiest way is to assume that the desired result is already achieved, so that there

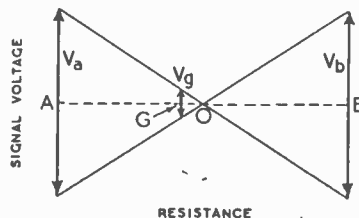

Fig. 2. Diagram showing signal voltage amplitude, as the vertical distance between the sloping lines, at all points between A and B along R_5 and R_6 . As V_a and V_b are assumed equal, O, the point of zero voltage, is at the centre point, with equal resistance each side. The required grid voltage is obtained at G, so AG represents the resistance of R_5 and GB that of R_6 . (For clarity, V_g is exaggerated, here and in Fig. 3.)

is at B a signal voltage which is equal and opposite to that at A. Visualising the voltage swings at A and B, and at every point along R_5 and R_6 , as up-and-down movements, we have something like a see-saw. As A goes up, B goes down, and vice-versa. Equal distances along the see-saw represent equal resistance steps (and therefore equal potential differences) along R_5 and R_6 .

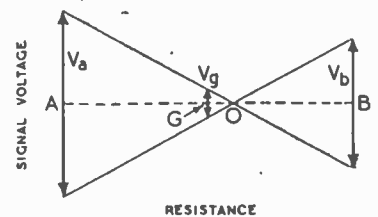

Fig. 3. Here R_5 and R_6 are assumed equal, so G is the centre point, and O is displaced. V_b is therefore less than V_a ; but the difference is small if V_g is very small compared with V_b .

At the centre, where the grid of the valve is connected, we have the fulcrum of the see-saw, at which the up-and-down movement is nil. In other words, the valve is delivering its output without any grid input, which of course is absurd.

But there is no need to be too downcast about this fiasco, because if the grid input connection is moved very slightly away from the electrical fulcrum towards A it will get an adequate signal voltage in the correct phase. Suppose again, for example, that the voltage amplification is 40. Then the grid tapping need be shifted only one-fortieth of the way from the centre to pick up the required voltage. This can be seen quite easily in the see-saw voltage diagram, Fig. 2, in which, if OG is $1/40$ th OA or OB, the voltage swing at B is -40 times that at G, which is what we have assumed as the performance of the valve. The ratio GB/AG

is then 41/39. Electrically, this requirement is met if R_6 is 41/39 (or 1.05) times R_5 , or in other words 5 per cent. more than R_5 .

It might appear at first that unless this small percentage difference is accurately maintained the system will not work properly; in particular, if the resistances were exactly equal it would not work at all. Fig. 3, however, will show that it was a mistake to jump to the conclusion that equal resistances are no good. Here the vertical line representing the grid swing has been drawn at the centre of the "see-saw" and one-fortieth as big as the swing at B. By joining up the corresponding arrow heads by means of the two sloping lines that indicate by the vertical distance between them the voltages at all points, it can be seen that the fulcrum is shifted slightly towards the B end, while the swing at A has to be slightly increased. A little elementary geometry shows that the voltage swing at B is now 5 per cent. less than that at A—a quite tolerable departure from strict balance. Even if the resistors were the wrong way round, so that R_6 would be 5 per cent. less in resistance than R_5 ,

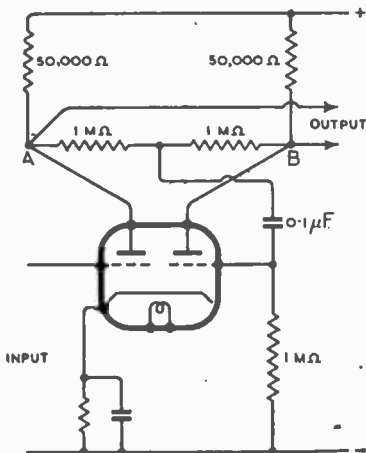

Fig. 4. Practical see-saw circuit employing a double triode valve

the error in balance would be within 10 per cent. If the amplification of the valve is greater than 40 (as can quite easily be arranged) the vertical swing at G is even less compared with that at B, the fulcrum O is consequently nearer the centre still, and the A

and B swings become still more nearly equal.

The great merit of what may appropriately be called the see-

no necessity for this valve to be of the same type as the phase splitter valve, but as both handle approximately the same signal

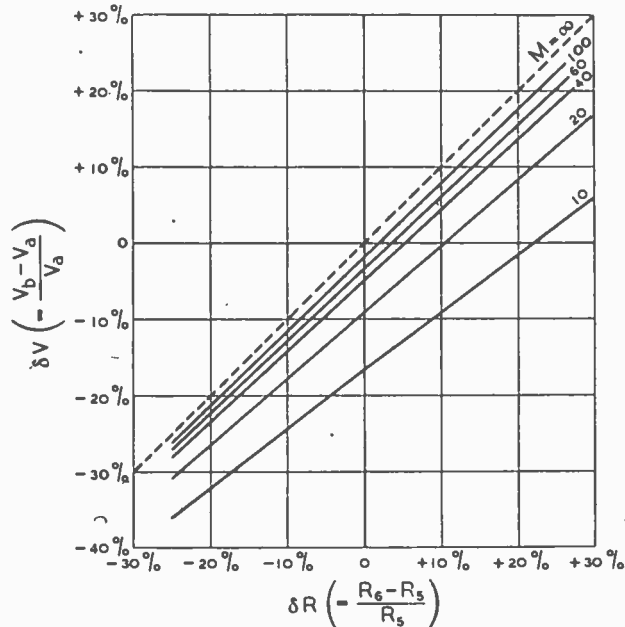

Fig. 5. Diagram showing the percentage departure from voltage balance (δV) in terms of the percentage difference between R_6 and R_5 (δR), for several values of amplification, M .

saw phase splitter circuit should now be apparent—its self-balancing properties. So long as the resistors R_5 and R_6 are equal within commercial limits, and the voltage amplification of the valve is reasonably high, their precise values are unimportant, and the voltage balance adjusts itself to compensate for variations. Suppose, for example, that the amplification falls from 40 to, say, 30. In Fig. 3 this would be represented by a shortening of the "B swing" line. The resulting scissors action of the sloping lines cause the fulcrum to move B-wards, and the swing at G to increase, thereby increasing the swing at B and limiting the change to a very small percentage. In this respect the system resembles a negative feedback amplifier, which, in fact, it is. For the same reason one may expect this type of phase splitter to be particularly free from distortion.

As already mentioned, S in Fig. 1 would, in a practical amplifier, be the output of a stage of amplification. There is obviously

view it is convenient for both to be the same, or to be the two halves of a double triode. Fig. 4 shows the latter arrangement. In the February article the use of the triode and heptode parts of a frequency changer valve was shown.

Finally, the general relationship between voltage balance, valve amplification, and resistance ratio, of which we have so far considered only a few typical cases, can be worked out from Fig. 2 as follows.

Let V_a , V_g and V_b be the signal voltages at A, G and B respectively. The fraction by which V_b exceeds

$$V_a \text{ is } \frac{V_b - V_a}{V_a}, \text{ which we can}$$

denote by δV ; and the fraction by which R_6 exceeds R_5 can similarly be called δR . The voltage amplification of the phase splitter valve is V_a/V_g (it is

$$\text{approximately equal to } \frac{\mu R_6}{R_a + R_6}$$

where μ is the amplification factor and R_a the internal res-

The See-saw Circuit— (sistance), and can be represented by M.

Then

$$\begin{aligned} \delta V &= \frac{V_b - V_a}{V_a} = \frac{OB - (AG + GO)}{AG + GO} = \frac{\left(1 + \frac{OB}{GO}\right)(OB - AG - GO)}{\left(1 + \frac{OB}{GO}\right)(AG + GO)} \\ &= \frac{OB - (2AG - AG) - GO + \frac{OB^2}{GO} - \frac{OB \cdot AG}{GO} - OB}{(2AG - AG) + GO + \frac{OB \cdot AG}{GO} + OB} \\ &= \frac{(GO + OB - AG)\left(\frac{OB}{GO} - 1\right) - 2AG}{GO + OB - AG + \frac{OB \cdot AG}{GO} + 2AG} = \frac{\left(\frac{GO + OB - AG}{AG}\right)\left(\frac{OB}{GO} - 1\right) - 2}{\frac{GO + OB - AG}{AG} + \frac{OB}{GO} + 2} \\ &= \frac{\left(\frac{R_6 + R_5}{R_5}\right)(M - 1) - 2}{\frac{R_6 - R_5}{R_5} + M + 2} = \frac{\delta R(M - 1) - 2}{\delta R + M + 2} \end{aligned}$$

This result is in a form convenient for plotting curves showing how the voltage balance depends on the resistance balance and the valve amplification, as in Fig. 5, where the "out-of-balance" is given as a percentage of V_a , for several values of M. When M approaches infinity, δR , 1 and 2 are relatively negligible,

and the formula reduces to $\delta V = \delta R$. This is expressed by the dotted line.

If R_6 and R_5 are assumed equal the unbalance can be read off the " $\delta R = 0$ " line. It is always negative (i.e., V_b less than V_a) and is less than 10 per cent. provided that M is at least 20.

For perfect balance, $\delta V = 0$, so $\delta R(M - 1) - 2 = 0$; i.e., it is necessary to make $\delta R = \frac{2}{M - 1}$.

ELECTRICAL CONTACT SPRINGS

A DISCUSSION on the above subject at an I.E.E. Radio Section meeting held on Tuesday, May 22, was opened by Dr. L. B. Hunt, M.Sc., and Dr. H. G. Taylor, A.M.I.E.E., who pointed out in their introductory remarks that the characteristics on which the design of a spring was based, were generally the pressure required to secure a satisfactory contact and the amplitude of the movement from the unstressed position. The materials most often used for contact springs were nickel-silver, phosphor-bronze or beryllium-copper. The limiting features were the stress induced in the material and the question whether it would withstand the corrosion conditions which existed. For static loads it was possible to compare materials on the basis of their proof stress, namely that stress which gave a permanent set of 0.1%, though the working stress should be less than this.

"Springiness" depended on the ratio of maximum safe operating

stress to modulus of elasticity. Copper alloys with a modulus less than two-thirds of that of steel were in many cases more suitable. This was of importance where there was a tolerance on the size of a spring contacting member, since the maximum size must not overstress the spring, and the minimum size must still provide adequate contact pressure. Beryllium-copper was the most springy of the possible materials, followed by phosphor-bronze.

Precipitation-hardening alloys such as beryllium-copper had the advantage that their best properties were produced by heat treatment, and any necessary forming could be done prior to this operation. The minimum permissible radius of right-angled bends varied with the type of material, with its hardness, and with the direction of the bend with respect to the direction of rolling of the material. A summary of a large series of tests was given in a paper by the openers entitled "Electrical Contact Springs" pub-

lished in the *Journal I.E.E.*, 1945, 92, Part III, p. 38.

In many cases the material of which a contact spring was made was suitable for the actual contact, but where pressures were light and a very low contact resistance was required, special materials must be employed. Electro-deposition of contact materials was widely used and was the only practicable way of using rhodium, which, in addition to being entirely free from tarnishing at ordinary temperatures, possessed remarkable wear-resisting properties. Its Vickers pyramid hardness might be as high as 800.

In the discussion which followed difficulties in working some of the modern spring alloys were discussed; for example, change of shape during heat treatment and the possible deterioration of silver plating on re-entrant surfaces which had to be plated before forming and heat treatment. It was pointed out that the former difficulty might be overcome by "nesting" and wiring parts which would fit together to give mutual support. Normally, the temperature required for heat treatment should not affect silver plating, but if it did, the solution was to use bimetallic strip in which the contact and spring metals were rolled together.

If component manufacturers wished to make the best use of improved spring alloys they would have to modify the design of contacts; many complicated shapes could only be formed in 70/30 brass. Rotary-type waver-switch contacts—formerly of silvered brass—were now being made in 50/50 copper-silver alloy. This was a better spring material, but required a higher contact pressure to give a low contact resistance.

The performance of platinum in relay contacts could still be regarded as the standard by which other metals should be judged. Gold alloys with silver, nickel or zirconium had been used in enemy countries, but were in the nature of a substitute. In high-speed telegraph relays a palladium-copper alloy gave greater freedom from cratering and pick-up. This alloy also gave good results in contact with nickel-chromium wire. Rhodium-plated phosphor bronze or beryllium-copper contact arms were also successful in this application. Rhodium was an excellent contact material for use in RF circuits where a low and uniform contact resistance was essential.

Silver-to-silver contacts were useful when good wiping action could be provided. For slide-wire contacts rhodium-to-rhodium or rhodium-to-silver gave good results. In the latter case the track should be silver and the contact rhodium.

HIGH-SPEED RADIO-TELEGRAPHY

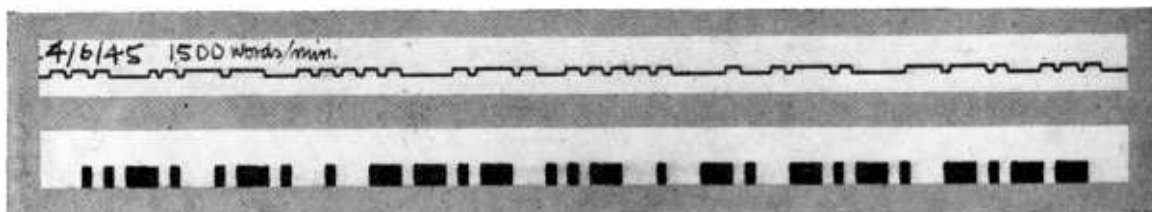

Details of the Romac 3,000 Word-per-Minute System

MOST of the available channels in those regions of the radio frequency spectrum which are best suited to long-distance propagation have already been allocated and further expansion depends upon better engineering use of existing channels. At the present time, although speeds up to 800 w.p.m. have been achieved with special relays, most traffic is handled at speeds between 100 and 200 w.p.m. so that an increase of operating speed to 3,000 w.p.m., claimed for the system to be described, would be equivalent to the use of an additional 20 channels.

In the Romac system, which was developed some years ago by a group of Polish radio engineers, including S. Lalewicz and Madame M. Konopkova, the limitations of mechanical relays have been avoided by using wax cylinder recorders, and circuits have been developed which give a stable signal of good waveform under

exceptionally severe conditions of interference and noise.

At the transmitter electronic keying is employed. The message is prepared in morse characters on paper tape, particular attention being given to uniformity in the lengths of marking and spacing elements. The tape is then run at high speed past a source of light and the reflected light is picked up by a photocell. The resulting impulses are given a square wave shape by a DC amplifier employing a new gas-discharge relay valve known as the "Teleion," and are then used to modulate the carrier direct, no subsidiary carrier being employed. Sidebands are limited by a double humped filter in the output circuit of the transmitter. The consequent deformation of the square pulses during radio transmission is corrected by a "Teleion" valve at the receiver. It is hoped to give a detailed description of the "Teleion" in a later article; for

the present purpose it is sufficient to state that at one point on its characteristic a very large change of output current is obtained for a comparatively small change of input. The action is reversible and the rate of change from the "active" to the "passive" state has been greatly increased by the use of a "glow up" electrode.

At the receiving end the first unit in the chain is a normal communications type receiver, the output of which is tuned to a beat frequency of 5,000 c/s. This is passed to an instrument described as the "Romac High-speed Telegraphic Unit, Model K 1" which has remarkable powers for extracting recordable signals from an apparently hopeless jumble of interference and background noise. The principle involved is a combination of AF selectivity, AC and DC limiters and automatic gain control. First the signal passes through a bandpass filter with a mean frequency of

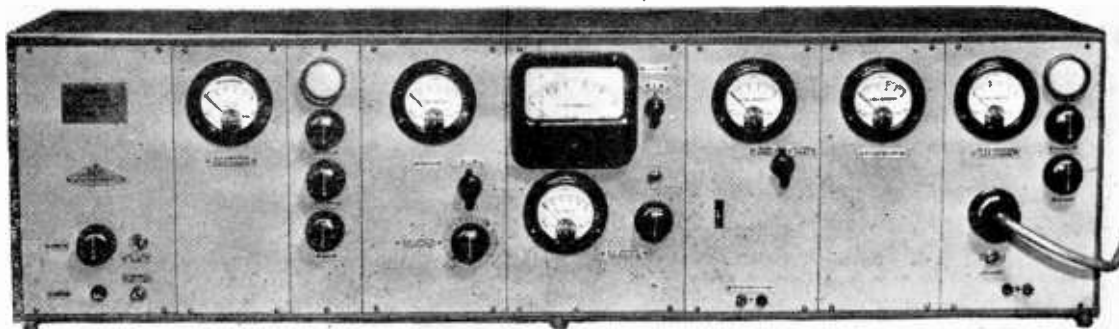

Romac Radio Corporation's Model K 1 High-speed Telegraphic Unit. At the head of the page is shown a specimen of receiver tape, and, below it, a section of the transmitter tape which actuates the electronic keying apparatus.

High-speed Radio-telegraphy—

5,000 c/s and a width of 1,600 c/s, then through a combination of no fewer than eight limiters in which both top and bottom limiting is involved. After this "ironing out" process a "Teleion" valve is used to restore the square waveform. Small cathode-ray monitoring oscilloscopes are provided to compare the input and output waveforms, and they give striking proof of the range

ferred to another machine running at a speed 20 and 60 times slower than the high-speed recorder. The carrier is now between 500 and 1,500 c/s and the morse speed is

sound box fitted with a microphone forms a convenient method of extracting the signal, which is now passed through the "Romac Rectilinear Telegraphic Reproducer Model L 1." In this unit, input circuits tuned to various fixed frequencies between 300 and 1,400 c/s provide further filtering from record surface scratch, etc., after which the waveform

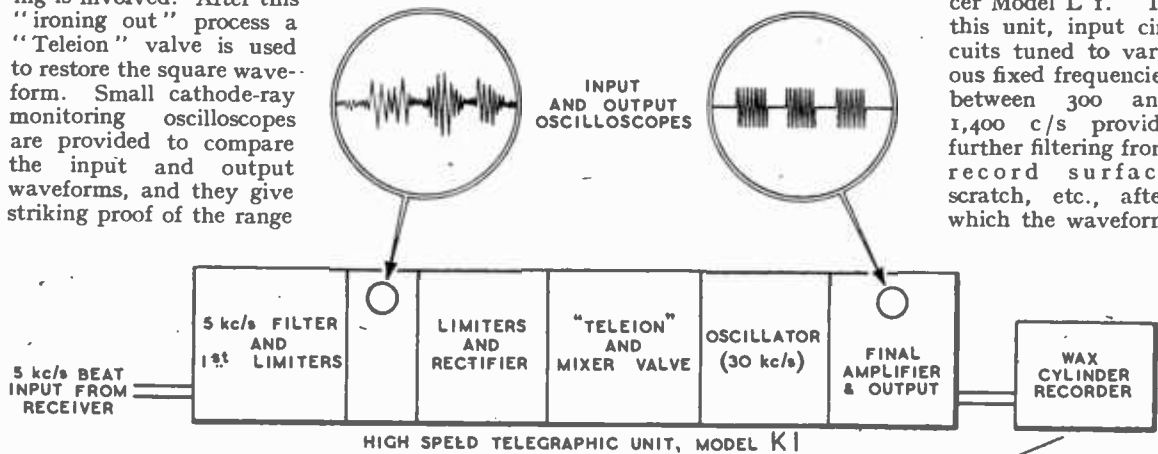

Simplified block diagram of the complete system.

of control. Weak signals hardly distinguishable by ear from the random noise level, and high-powered stations which send the input trace right off the scale produce the same perfectly regular square-wave signal of constant amplitude on the output CR tube.

The high-speed recorder is a modified wax cylinder machine as used in offices for dictating correspondence. It is provided with a piezo crystal cutter and runs at 700 r.p.m. Signals are recorded at a fixed "carrier" frequency of 30,000 c/s which is modulated by the output from the "Teleion."

The wax record is next trans-

well within the capacity of ordinary telegraphic undulating tape recorders. At the reduced audio frequencies a standard acoustic

of the morse impulses are again reformed by a "Teleion" relay. In this case, however, the wave is not necessarily limited to a square form, but can be given a variety of shapes to suit the mechanical characteristics of the undulator. For instance, an initial peak of current can be provided to accelerate the movement, and an inverse peak to return it to zero after a dot or dash. By "tailoring" the waveform to suit the instrument, the maximum speed of an indifferent recorder can be greatly increased.

A special feature of the Romac system is its facility for recording reliably under conditions of poor signal-to-noise ratio, and the methods used are such that although they were produced in the first instance for the recording of very high telegraphic speeds, they can be usefully employed for the recording of very weak signals of slow or commercial speeds.



Romac Rectilinear Telegraphic Reproducer, Model L 1.

RADIO PROSPECTS

Post-war Jobs for Technicians

"WHAT are my post-war prospects as a radio technician?" is a question that is being asked by many men in and out of the armed forces. The answer to that question cannot, without some consideration, be answered in any other way than "Nobody knows." It is the purpose of this article to outline some of the problems which must be solved before we can hope to plan the future for electronic technicians; planning, it must be emphasised, can only satisfactorily be done by technicians themselves. As the word "planning" has direct reference to the shaping of society and its activities, it follows that the scope of this contribution lies in the political field, and not in the technical. Yet the writer wishes to make it clear that the argument is not governed by any considerations of party politics; socialism *versus* capitalism, or, in fact, of any "ism" at all. The views expressed are the outcome of much experience in wartime production and design for Government departments and others, and also of a wide and varied experience of radio work in the years between the two wars. So far as it lies within the power of any individual to rid himself of prejudices, the writer offers what follows as a purely objective examination of the situation in which we, as radio men, find ourselves.

It will be recalled that in 1939 radio design, production, and selling, was taking on a rather depressing shape. Even the radio exhibitions of the immediate pre-war years were unsatisfactory from a technical viewpoint, because they were not so much exhibitions displaying new products and new methods as well-organised propaganda institutions. Possibly radio was never suitable for the sort of show that made the motor or cycle exhibitions so popular.

There is, of course, no reason why the public should concern itself with the "innards" of their broadcast receivers. All they

By H. A. HARTLEY

were interested in was service in the home, and so long as the sets looked nice, sounded moderately good, and went on working, they did not care very much about how it was done. They asked only that it should be done. And, from a value-for-money point of view, the pre-war sets were fairly good.

But they were not good sets. There was quite a large number of listeners who did not like the sound of them, and these people generally tried to get something better from the specialist manufacturers; the people who turned out more or less "high-fidelity" receivers. We shall not here reopen the old controversy about high or low fidelity; let it suffice if it is said that permanent musical interest can only be sustained when the quality of reproduction does not fall below a certain fairly high standard; and the standard of reproduction in the mass-produced sets was lower than this. As a consequence, the public in general, never more than low-brow, found that their sets sounded very much the same whether they were 1928 or 1938 models; and they only bought new ones if the old one broke down, and wasn't worth repairing, or they "fell for" the new sales features, such as short-wave reception (that was rarely used), or push-buttons, or remote control.

What the Public Wanted

Now it must be realised that designers and manufacturers did not produce these mediocre receivers just because of wilful perversity. High-fidelity reproduction is not only costly, but it has the disadvantage that distortion outside the receiver, as well as interference and side-band "splash," is also reproduced at high fidelity. Experience showed that, in general, the public would not pay the price for high musical quality, nor put up with the

noisy background when the field strength of the local station was inadequate. Under the existing economic system the manufacturer was left with the alternative of making what was readily acceptable to his customers, or of going bankrupt. The less competent manufacturers were very nearly bankrupt in 1939, even when they made what they thought the public wanted; for, in a situation where it was known with reasonable certainty what would sell and what would not, the rewards went to those firms which ran their organisations most efficiently.

Here, then, is something that radio technicians must bear in mind: that their business feature under "private enterprise" economics depends largely on the efficiency of the firms they are working for; and that their technical scope is severely limited by the fact that their employers are under the necessity of producing equipment which will give a performance which the market is supposed to demand, and that demand has its roots in cheapness rather than excellence. Admittedly there are exceptions to this statement; but experienced engineers will appreciate that, in a general way, it is true. Pure research can only be undertaken by large and wealthy corporations or Government establishments, and the number of available posts has always been very limited.

The position in the field of television was much more promising, for this was, in effect, a new industry; even so, it was becoming clear that a similar situation would arise after a few years. The financial resources required to cope with the accepted policy could only be provided by the large concerns, and once again, definition and quality of picture reproduction was limited by the overwhelming urge to cut the cost to the bone so that the widest market could be tapped.

We can conclude this pre-war review by summarising the salient features of the situation.

(1) The over-riding necessity,

Radio Prospects—

in an economic system of free enterprise, to provide that commodity which was most easily saleable, resulted in radio and television receivers having to be built down to the lowest possible price consistent with reasonable reception, good appearance, and moderate reliability.

(2) The distribution of these receivers to the public had to be effected through the medium of retailers, a very large proportion of whom were not competent to give good technical service to the people who bought the sets. This had become so widely recognised that some manufacturers instituted systems of properly accredited dealers equipped with adequate servicing equipment, so that the good name of their sets would not be ruined.

(3) The result of 1 (above) on the technician's prospects was very unsatisfactory. Other things being equal, the most competent engineer, or the one with the best "references," got any job that was going. Yet, installed in his post, he was at the mercy of circumstances beyond his control. His allotted task was limited by the fact that his employers were under the necessity of producing equipment which conformed to a specification determined by sales managers, who were motivated by the whimsical outlook of the public. The technical programme was, therefore, not one in which perfection was aimed at, but a bastard sort of compromise between low cost and reasonable performance. Even when the engineer had done his best under these difficult circumstances, his continued livelihood depended on the production executives' skill in making large numbers of equipments which gave the designed performance; and, finally, on the ability of the sales executives to dispose of the manufactured goods. If either the producers or salesmen failed to perform their tasks, the engineers suffered equally.

(4) As a consequence of 2 (above), technicians who were employed by retailers as servicemen were often badly handicapped by lack of equipment. As in industry, the technician working for a well-run firm was reasonably secure and happy; yet an equally competent man who had

the misfortune to be employed by one of the less savoury concerns had a hard time of it. Financial reward and future prospects were not identified with technical competence.

Change-over to War

It can certainly be said that design and production for war requirements has been totally different from what was needed in pre-war days. A very large proportion of design work and the developing of prototypes was done by Government establishments, and the staffing of these establishments presented some difficult problems. These establishments existed in skeleton form as far back as the days of appeasement. They were staffed by a mixture of permanent civil servants and recruits from industry, but were almost exclusively administered by that type of individual popularly known as a bureaucrat. The permanent civil servants had been brought up in an easy-going tradition, where time and cost were not so important as in the world of private enterprise, and the recruits from industry found this *tempo*, and the dead hand of officialdom, frustrating. As the ministries and research establishments expanded, it was found that the more experienced and energetic of the technicians in industry were disinclined to give up good positions in the outside world for the problematic advantages of a temporary post carrying little or no responsibility. Accordingly, it was inevitable that many members of the staffs for these Government departments were recruited from the ranks of unemployed salesmen, shopkeepers, and semi- or non-skilled radio men of little value to the manufacturers. Yet these people had no little influence on the nature of the equipment that would finally emerge from the factories, and as their efforts very often resulted in designs which were not well adapted for production in large quantities, bitter arguments and discussions were always taking place between Government officials on the one hand, and manufacturers on the other.

It must not be supposed, however, that the manufacturers were beyond criticism. Many firms had had a great deal of experience in

producing large numbers of comparatively low-grade receivers, and found the exacting requirements of the armed forces difficult to meet. Government inspectors found themselves faced with having to reject large quantities of component parts or complete equipments, and the "cost-plus" system of paying for contracts placed little or no obligation on the manufacturer to take a more realistic view of what he was doing, or supposed to be doing. This pernicious business added to the irritation from arguments with Government design staffs created an atmosphere of inefficiency and resulted in unsatisfactory production.

This had its effect on the technicians and engineers. Those in Government employment were unpopular with the industrialists because their ideas were considered unpractical, while production officers considered manufacturers inefficient because they did not produce the goods. Technicians in temporary Government employment will accordingly note that this frame of mind among manufacturers is not likely to be conducive to their future employment in industry.

Inadequate Production

One thing is, however, perfectly clear to those who have been concerned with the design and production of electronic equipment during this war (and the same may be said of other types of war production, too, in case our radio magnates take umbrage at what is going to be said). Production in this country, with but a few notable exceptions, has been inadequate to cope with the requirements of the fighting Services. A few production units have done a marvellous job of work in wartime radio production. This good work has been done by some very competent managers and executive engineers who have been freed from the red-tape of existing organisations, and have planned for and achieved first-class results. But what will be the fate of these wartime factories? In most cases they will no longer be required in the post-war world, and the industry will revert to its normal set-up, with, presumably, the atmosphere which made the pre-war organisations unable to cope

with wartime requirements. The best of the technicians at these temporary production units will, of course, be absorbed into the peacetime staffs, but there will be no jobs for the less worthy.

Jobs for Servicemen

Also to be considered are the skilled and semi-skilled radio men in the Forces. A number of these have received very good training in the servicing and repair of equipment, and with some modification in technique they could undertake the servicing of domestic radio and television sets. But who will employ them? Will it come to pass that they will drift out of the Forces into the shops of the radio dealers, as and when opportunities arise, or will the manufacturers start a chain of repair and service depots of their own? It is probable that, unless some plan is evolved for the rational employment of these men, they will simply be left to shift for themselves; and that will indeed be demoralising, for there are definite signs that the men expect that their specialist training will ensure them reasonably lucrative employment in the years to come. And what of the qualified engineers and scientific workers, in and out of uniform, whose wartime jobs will soon cease? On a still higher level, what is to be the fate of such highly expert Government establishments as T.R.E.? Are they to be continued as State organisations, or disbanded because they will no longer be necessary, or potential dangers to private enterprise?

It cannot be denied that, at the present moment, the future for radio engineers, research workers, and less highly skilled men who might be attached to the industry, is, to say the least, uncertain. It becomes still more uncertain when we realise there are many indications that the U.S.A., with their flair for showmanship and salesmanship, are likely to pre-empt the larger part of the market for radar and other non-broadcasting electronic devices. It appears that the British radio industry has not had the vision or the energy to plan boldly for post-war development and production of these devices, which call for a selling technique of a very

different type from that required for domestic broadcast receiving equipment. So far as the writer has been able to discern, we seem to be in great danger of seeing this most important branch of

electronic production handed to America "on a plate."

In a concluding instalment the author will make suggestions for the peacetime reorganisation of the radio industry.

ELECTRICAL AIDS TO PUBLIC SPEAKING

Discussion at an Informal Meeting of the
I.E.E. held on April 23rd, 1945

IN opening the discussion P. G. A. H. Voigt, B.Sc., recalled the Institution's first electrical aid to speakers, when some years before the present war a piece of apparatus was placed on the Chairman's desk in the Lecture Theatre to indicate to speakers in any part of the theatre whether they could be heard. The apparatus showed a light when the loudness of the speaker's voice was adequate.

Mr. Voigt said it was usual to see pictures of people addressing the public, in which the speaker was hidden behind an array of microphones. He maintained that something far less conspicuous should be used and showed two types of small microphones, one of which was a ribbon type made for laboratory use. He disliked the practice of placing one or more microphones in front of the speaker and suggested that two should be arranged on either side to ensure audibility. Moreover, this method would not make the speaker so microphone conscious.

On the subject of directional or non-directional loudspeakers, his own view was that the audience should not be aware that electrical aids were being used, and he deplored the effect when loudspeakers were heard from a different direction from that of the speaker. Tone controls in amplifiers could be very helpful owing to the differences of response in different halls.

In the discussion attention was drawn to the value of attenuating the lower frequencies in speech; it was pointed out that when the human voice is amplified beyond its original intensity, the lower frequencies are proportionally

louder and tend to mask the higher frequencies.

The idiosyncrasies of stage performers in regard to the use of microphones and loudspeakers received considerable attention, and the suggestion was made that the management of a circuit of theatres or music-halls would be well advised to engage a sound engineer as a permanent member of their staff. The proper supervision of the installations would prevent some of the unpleasant sounds which are often heard. It was said that some singers and artistes like to hear how their voices are projected, and that directive loudspeakers affording them a measure of "side-tone" were sometimes installed.

The question of overcoming the acoustic shortcomings of the hall or room rather than those of the person talking was regarded by one speaker as the real problem, and the control of reverberation time was also mentioned.

The need for collaboration between sound engineers and architects in the design of theatres, music-halls and large buildings was emphasised. Too often a public-address installation was ordered after the building had been erected and a satisfactory system was hoped for, rather than designed.

Mr. Voigt, in his reply to the discussion, said that maintenance was always a difficult matter. It seemed to be thought that installations would work for years without attention, and although there was sometimes a willingness to spend quite large sums on installing the equipment, a subsequent charge for maintenance was often grudgingly met.

DISTORTION IN AF TRANSFORMERS

Testing Core Materials at Low Signal Levels

By THOMAS RODDAM

IT is well known that iron-cored transformers are not strictly linear devices and that in consequence they can produce harmonics and intermodulation terms. The analysis of this effect involves assumptions of the shape of the hysteresis loop, and the performance which is predicted depends on the nature of these assumptions. One method, described in reference 1, chooses a fairly broad assumption, that the hysteresis loop is symmetrical about the origin, and that each branch can be represented by a power series. The analysis in this paper uses the third harmonic distortion as a typical criterion and arrives at the conclusion that the RMS voltage of third harmonic, E_3 , produced by a fundamental current I (RMS) in a coil of n turns is proportional to $I^2 n^3$.

An alternative treatment is rather simpler. It is assumed that the B-H curve is made up of two parabolic loops, and this leads to the approximate equation

$$E_3 = \frac{4\alpha H_m}{5\pi\mu_0} E_1$$

where E_1 and E_3 are the fundamental and third harmonic peak voltages applied to the coil, H_m is the maximum value of flux density, and μ_0 and α are the permeability and the non-linearity coefficient. This leads to the conclusion that E_3 is proportional to E_1^2/n , where n again is the number of turns in the coil.

known to the author gives information on the coefficients which turn these expressions of proportionality into equations which can be used by a designer. It is useless to know that the distortion is proportional to the square of the flux density if the constant of proportionality is not known.

A further difficulty arises with some core materials. Indications of what may happen appear in references 2 and 3, but the actual effects from a circuit designer's point of view are rather surprising. They lead, in fact, to the conclusion that any transformer may have an "intrinsic distortion coefficient." Instead of the ratio of harmonic to fundamental diminishing towards zero as the flux density or signal level is reduced, the distortion tends to a finite value which may be greater than 1 per cent. This effect has only been examined in pre-war nickel-iron alloys, but it suggests that the shape of the hysteresis loop of these alloys deserves careful study and that there is sometimes an extra price to be paid for high permeability, in addition to the usual problem of eliminating or balancing the DC component in the magnetising coil.

The experimental technique used in the study of this effect was briefly as follows. A generator of

with the load, and the third harmonic voltage was measured at various signal levels. The circuit is shown in Fig. 1 and it will be clear that the coil is acting as an auto-transformer of 1:1 ratio.

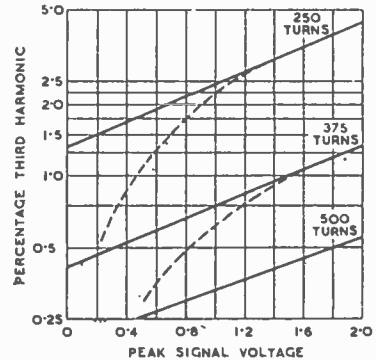

Fig. 2. Third harmonic distortion at various input levels produced by iron-cored coils bridged across 500-ohm line. Frequency of fundamental 50 c/s.

The curves of Fig. 2 show results typical of what was found. The solid lines are experimental, and the dotted lines show what would have been predicted by the straightforward theory. It will be noted that the distortion at low levels is much greater than would be expected from high-level, and consequently more accurate, measurements. Analysis of the results also led to the conclusion that the distortion was inversely proportional to the cube of the number of turns.

In studying the behaviour of core materials it is proper to relate effects to the flux density in the core. This is, in theory, the only stimulus available to the core to control its behaviour. Unfortunately it has been found impossible to rationalise these results in this way. The distortion does not appear to be a unique function of the flux density, but depends also on how this flux has been produced. For this reason, Fig. 2 is presented solely as a record of the experimental work, and no attempt is made to relate the distortion to the flux density. Without a full understanding of the

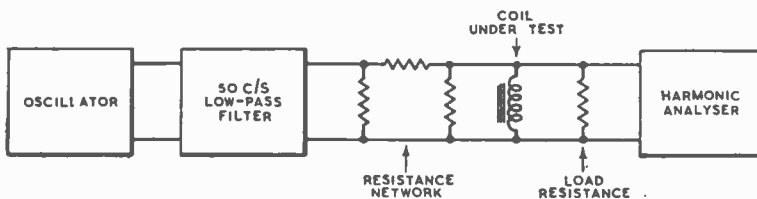

Fig. 1. Circuit used for distortion measurements.

These treatments are abbreviated here because they are not really very useful in practice. Their chief function is in rationalising the results of experimental work in which the relationships have already been tested. No manufacturer of core material

pure waveform and stable 50 c/s frequency was set up with a fixed generator impedance. A resistive load was provided, and a high-impedance harmonic analyser bridged across this termination. A coil wound on the core under test was then connected in parallel

mechanism of this effect such an attempt would be without justification.

Two conclusions can be drawn from the results described. The first is that an investigation of the detailed behaviour of iron alloys as transformer cores is needed. The second is that the transformer designer must, when using an unfamiliar material, examine not only the non-linearity coefficient, but also the law which his material follows.

REFERENCES

- 1 "Harmonic Production in Ferromagnetic Materials at Low Frequencies and Low Flux Densities," by E. Petersen. *Bell System Tech J.*, Vol 7, p. 762 (1928).
- 2 "Design of Audio Input and Intervalve Transformers," by J. G. Story. *Wireless Engineer*, Vol. 15, No. 173. February, 1938.
- 3 "Magnetic Characteristics of Nickel-Iron Alloys with Alternating Magnetic Forces," by E. Hughes. *J.I.E.E.*, 79, p. 213 (1936).



SUCCESSOR of the well-known infantry set No. 18. This short-range transmitter-receiver, the 68P, operates in the 1.75 to 2.9 Mc/s band with crystal control for sending. It has facilities for 'phone and CW operation.

WRITING TEXTBOOKS

Guidance for Would-be Authors

By A. U. THOR

THE recently published attack* on the wartime spate of bad radio textbooks is unfortunately only too well justified. That high quality books will be needed after the war and that they will be a valuable asset in our export drive is freely admitted. The article may lead some of those engineers who have had little spare time during the past five and a half years to add authorship to their activities. An analysis of my own experience in this sphere, accompanied by some general comments, may therefore be helpful.

It is unusual for a publisher to sign a contract with a budding author, lacking a reputation both professionally and as a writer, without seeing the complete MS. of his book. But publishers are often willing to commission an author having acceptable qualifications and experience as a result of seeing, say, a specimen chapter with, perhaps, the headings and sub-headings of other chapters of the proposed book. Some publishing companies are dilatory, but as a rule a contract is offered or refused within a month or two of the receipt of the script.

Unless a book is phenomenally successful an author cannot expect a high money rate per hour as a reward for his labours; he will find, however, that the time spent upon his book will have been well worth while from his own educational point of view. He will probably find gaps in his technical knowledge, which he himself will have to fill, and the results of his work might form the basis of technical articles to help increase his financial return. In my own case about eight years of spare time went into a textbook of some 800 pages, and this meant eight years of evenings of comparative silence for my wife. So, married men, consult your wives before beginning!

Choice of subject must depend

partly upon the author's inclinations, and partly upon an examination of the whole field to see what part has not been adequately covered. It is always a good thing to have a specialist bent, because a general book on radio tends to be just a rehash, and often a poor one, of what has already been written.

A prospective author would be well advised to read G. E. Williams on "The Presentation of Technical Literature" in Part I of the *I.E.E. Journal*, Vol. 91, May, 1944, before beginning even the main outlines, which should include a rough draft of chapter sub-headings.

The really hard work of collecting data has now to be tackled, and a loose-leaf book, divided into a number of sections in accordance with the chapters and their sub-headings, is essential. The question arises as to how far back in past literature it is necessary to go, and in the writer's experience about fifteen years is generally sufficient. The *Wireless Engineer* "Index to Abstracts" is usually the best source of information, and the would-be author should examine these indexes from, for example, 1930 onwards, noting under the appropriate heading the titles and dates of any articles which seem to be apposite. After this comes the task of abstracting the relevant information from the articles selected.

As to the book itself, content and layout are all equally important factors in failure or success, and a short, "snappy" title must be chosen. No attempt should be made to produce a finished polished style in the preliminary draft, which ought to be merely a record of the author's thought processes. It is not essential to follow numerical chapter order; the writer preferred to take the most difficult chapter (which happened to be the last) first. The final draft should aim at simplicity and lucidity with economy of words. The B.S.I. "Glossary

* Radio Textbooks, T. Roddam, *Wireless World*, June 1945, p. 186.

Writing Textbooks—

of Terms used in Telecommunication," B.S. 204:1943, will give the accepted technical words and expressions. Many engineering publications make difficult and tiresome reading because they are written in an almost pure Latin style. How often does the word "utilise" appear when "use" is meant. In the writer's view "I" should never be used though "we" is permissible in contexts where it helps to establish a link of fellowship between author and reader.

Subject matter must be up to date and accurate, with sources of information quoted in as extensive a bibliography as possible. "It can be proved that" should always be accompanied by a reference to the article or book where proof can be found. Intermediate steps in mathematical developments ought not to be omitted, and practical values should always be quoted to show the relative importance and dimensions of the quantities involved. A reader should never be left in any doubt as to the validity of a simplified mathematical formula under all conditions, and the simplifying assumptions must be clearly stated.

Layout of the book is not entirely within the author's control, though most publishers consult him. It is a more important factor than is generally realised. How many have picked up a textbook only to be put off by poor drawings, bad paragraphing and headings. All drawings must be uniform in style and should be drawn by a professional artist-draughtsman, appointed and paid by the publishers. It is very dangerous to try to get this work done privately, particularly as for subsequent revisions the same draughtsman may not be available. For this same reason no author should (except in very special circumstances) reproduce an exact copy of some diagram or curve from a periodical or technical journal. It should be redrawn by the draughtsman. Photographs of "present-day" equipment are best left out, because in radio work equipment tends to change so rapidly.

Proof checking is always a tiresome business, but is an essential part of the work—the long-suffering wife comes in again here.

A list of the points to be checked, like diagram sequence, headings, page numbers, etc., should be always before the author. After routine checking of typescript, the author should always carry out a sense check to see that the correct technical meaning is conveyed by the text. If a technical friend is willing to undertake this, so much the better.

Last, but not least, there is the index to be prepared. Too many authors seem to lose interest at this stage and are satisfied with a very scanty index. This is "spoiling the ship for a ha'porth

of tar." The best method the writer has found is to have 24 thin white cardboard sheets (postcard size), each bearing a letter of the alphabet. Nouns, adjectives, and verbs regarded as of technical importance are used to place an outstanding phrase under its appropriate letter or letters. Thus "Modulation envelope distortion in RF amplifiers" would be under M, E (envelope, modulation, distortion in RF amplifiers), D (distortion, modulation envelope, in RF amplifiers), and R (RF amplifiers, modulation envelope distortion in).

SELF-HEALING PAPER CONDENSERS

A NEW development in the manufacture of paper-dielectric capacitors of the tubular type has enabled A. H. Hunt Ltd. to produce a range of quite small capacitors possessing some unique features. This is achieved by employing a specially processed metallised paper in place of the customary paper tissue and separate metal foil.

The existing series includes capacitors for working voltages of 150, 250 and 350 volts DC at an ambient temperature of +71° C. Capacities range from 0.05 μF to 2 μF and the nature of the finish can be either a waxed cardboard tube or a synthetic rubber Neoprene sleeve. Enclosed in Neoprene the maximum permissible temperature is raised to +85° C. but the working voltages have to be reduced slightly.



Hunt's metallised paper capacitors; showing one of 0.1 μF and one of 0.5 μF capacity. As the larger is comparable in dimensions to a standard pattern paper tubular of 0.1 μF it serves as a basis for comparing the size of the smaller 150-volt type. The larger is for 350 volts DC working.

Unlike the average paper capacitor, test voltages for the metallised type are not much in excess of the working voltages, in which respect they resemble electrolytics. Likewise surges and high peak voltages can prove harmful. But within certain voltage limitations a momen-

tary overload will not irreparably damage the capacitor and even should the dielectric be punctured it will usually re-seal itself. This self-healing quality is an important contribution to the technique of paper capacitor construction.

Whilst the insulation resistance of these units is somewhat lower than is customary for paper capacitors, it is nevertheless adequate for most purposes. For the 150-volt type it is given as 50 ohms/farad, which for a 1- μF size gives a value of 50 megohms and for one of 0.1 μF the insulation resistance works out at 500 megohms. These figures are about doubled for the 250- and 350-volt pattern. The reason for this is that in the higher working voltage grades an additional tissue of paper is used to reinforce the dielectric. As a further consequence the physical size for a given capacity in these ratings approaches nearer to that of the average standard tubular capacitor. It still retains the self-healing qualities however.

These new metallised capacitors will serve for most purposes provided they are used within their rated voltages, but there will undoubtedly be some further developments. For example, although their behaviour in AC circuits is well understood by the makers they are not, so far, being recommended for use in any other but RF, AF and DC circuits, which, except for the power unit, covers all positions in an average radio receiver, amplifier and hearing-aid. The 150-volt range should prove eminently satisfactory in the last-mentioned equipments in view of their diminutive size. A 0.1- μF 150-volt capacitor is about only one-tenth the volume of a standard paper tubular of the same capacity.

Close tolerances are not being attempted in the metallised paper styles, ± 25 per cent. being the best that is claimed at present.

SYNTHETIC TRAINING FOR AIRCREWS

*Aerial Navigation
by Wireless
Practised on the
Ground by
Artificial Aids*

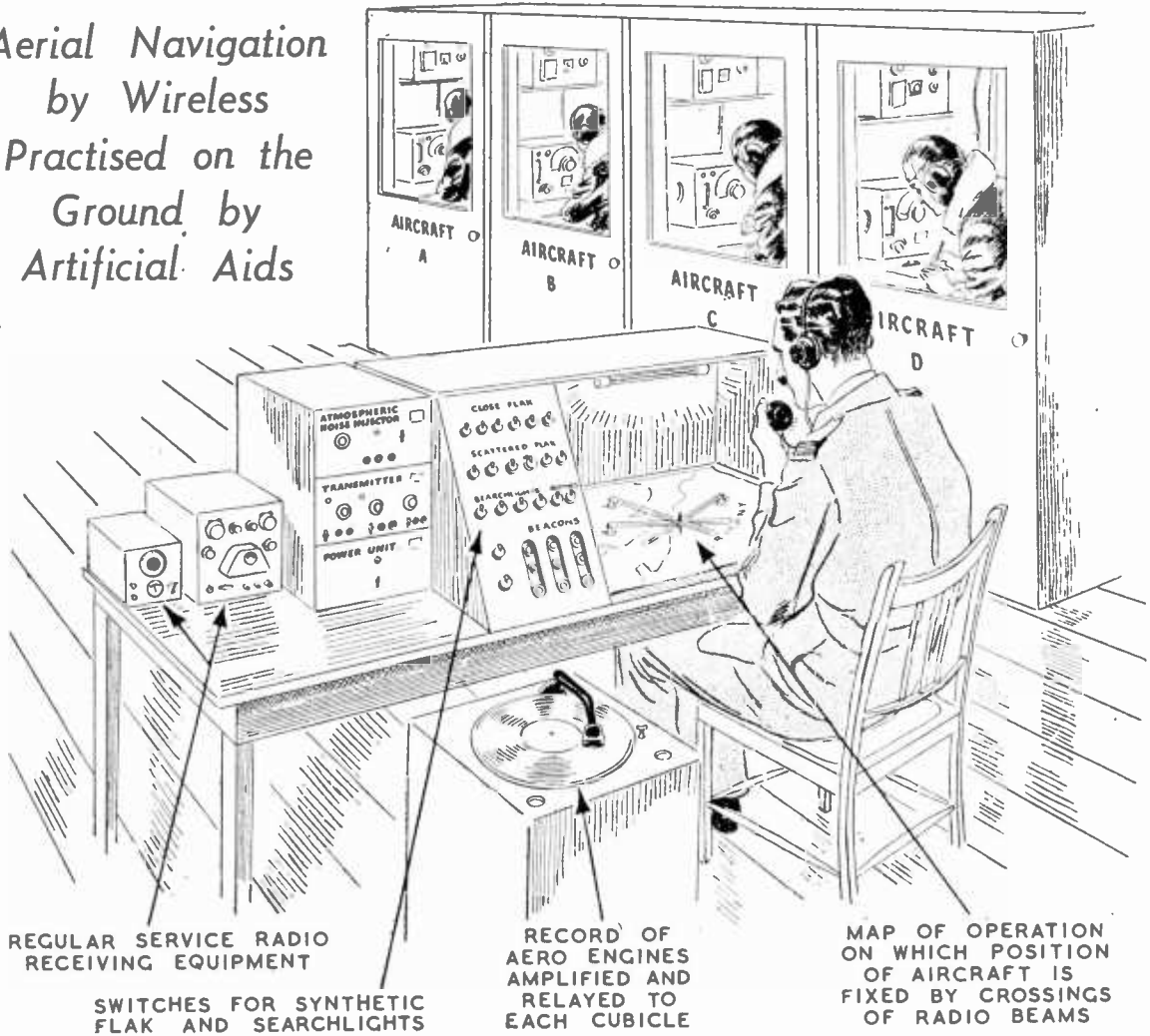

REGULAR SERVICE RADIO RECEIVING EQUIPMENT

SWITCHES FOR SYNTHETIC FLAK AND SEARCHLIGHTS

RECORD OF AERO ENGINES AMPLIFIED AND RELATED TO EACH CUBICLE

MAP OF OPERATION ON WHICH POSITION OF AIRCRAFT IS FIXED BY CROSSINGS OF RADIO BEAMS

A SCHEME for the collective training of bomber aircrews after they have received their individual specialised instruction was evolved quite early in the war by Redifusion Ltd. and afterwards embodied in a comprehensive ground trainer made by that firm for the Allied Air Forces. The basis of the scheme is that the key members of the crew, pilot, navigator and wireless operator be brought together in a synthetic aircraft and with the aid of apparatus controlled externally by an instructor the crew fly and navigate the aircraft in very much the same

way as if they were on an actual operational flight.

Mechanical substitutes for training in the air have been used in the Royal Air Force for some years past, the Link Trainer being perhaps, the best known device of this kind. As the opportunity to profit by mistakes made in the air comes to a few only, any pre-operational training of aircrews as a team and under conditions where such mistakes can be corrected by a competent instructor must be a valuable contribution to their efficiency.

The synthetic aircraft used for this purpose may be either the

appropriate section of an actual aircraft, or merely a cubicle fitted internally with all the equipment normally carried by the particular aircraft it is intended to represent. The essential point is that, so far as is possible, an atmosphere of reality should prevail.

As position-finding by wireless plays a major part in modern air navigation the Redifusion crew trainer is very largely devoted to presenting the wireless operator with a replica of the radio signals transmitted by the beacon stations for his use. Realism is obtained by feeding synthetic signals into a standard aircraft receiver in

Synthetic Training for Aircrews—

such a manner that bearings are taken by manipulation of the normal controls, the procedure being in every way the same as would be carried out when receiving signals in an aircraft from genuine beacon stations. The same kind of radio interference encountered on the particular frequencies used are exactly reproduced and mixed with the DF signals in increasing proportion as the instruction progresses.

Provision is made for the instructor to talk to the wireless operator either by breaking in on the aircraft's intercommunication system, or by the use of a predetermined radio channel. By muting all other signals the instructor can warn the pupil that he has something to tell him and the pupil then tunes his radio set to the appropriate frequency. The first-mentioned method is probably more satisfactory as the instructor can address his remarks to one of the several crews he may have under his care without interrupting the work in the other cubicles.

meter, a device normally used in DF equipment to determine the relative amplitude of signals induced in a fixed aerial system from a distant transmitter.

Synthetic DF Bearings

In the Redifusion trainer the search coil of the radiogoniometer in the artificial aircraft is mechanically linked to the standard loop rotating mechanism and electrically connected to the loop terminals of the aircraft receiver. The two crossed field coils are each connected by screened cables to the corresponding coils of another radiogoniometer located in the instructor's control equipment.

The search coil of the instructor's radiogoniometer is joined to a low-power RF generator which can be modulated to simulate the signals radiated by a typical fixed DF beacon station. Now when RF currents from the artificial beacon station flow in the instructor's goniometer search coil, similar RF currents are induced in the two associated field coils and the relative magni-

goniometer which has the same relationship to its field coils as the flux of the instructor's search coil has to its associated field coils. Thus any rotation of the instructor's search coil will cause a similar displacement of the magnetic field within the pupils' goniometers. The search coil in the aircraft cubicle can thus be used in much the same way as a loop aerial would be for taking radio bearings. Signals from the artificial beacons are injected into the open aerial terminals of the receiver and when mixed with the search coil signals reproduce the conditions for "sense" determination.

In an aircraft a radio bearing is neither a true nor a magnetic bearing, but merely the relationship between the fore and aft line of the aircraft (unless arranged otherwise) and the beacon station. Conversion to true, or magnetic, bearing has to be made by taking into account the actual course flown by the aircraft. The compass gives this information.

To simulate a change in course in the synthetic trainer first the

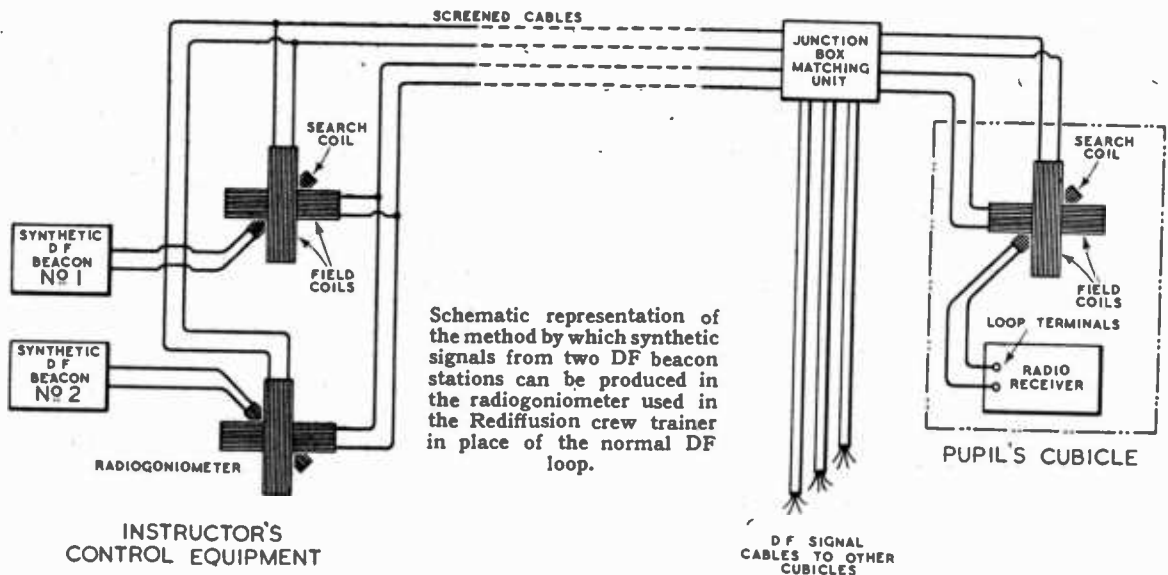

Several modifications have had to be made to the standard radio equipment in order to reproduce artificially the actual conditions obtaining in the air. Normally DF bearings are taken with a rotatable loop aerial, but as space-wave radio signals are not used in this trainer the loop is replaced by a radiogoni-

tudes of these currents will depend on the angular position of the search coil with relation to the two field coils. As these field coils are joined by a cable to similar goniometer coils in the cubicle, RF currents of the same relative magnitude will flow in the latter. These currents produce a magnetic field within the

compass indication of direction must be changed and secondly the relation between the fore and aft line of the cubicle and the axes of its goniometer field coils must be changed appropriately. But the search-coil-DF-loop must remain stationary.

Needless to say, the compasses fitted are artificial and the appro-

priate changes in course are made on a master compass under the control of the instructor. This not only controls all the compasses in the cubicles, but by means of suitable coupling mechanism rotates the field coils in the pupils' goniometers by the correct amount.

The crossed radial arms seen over the map in the illustration of the trainer are used to plot the course of the aircraft. As these arms are joined, at their pivoted ends, to the spindles of the beacon goniometer search coils the correct signals are automatically produced in the pupils' goniometers for

exact reconstruction of the course set by the instructor. This is the responsibility of the navigator who bases his reconstruction on the information provided by the wireless operator, and, in some of the more elaborately equipped trainers of this kind, also on astral observation provided by utilising mirrors and spots of light.

The atmosphere of reality can be heightened, if required, by introducing searchlights, also near and distant flak, by using light beams and firing flashes outside the cubicles. Internally, these have

only the very diffused lighting prevailing in a bomber on operational duties at night. Control of the artistic touches is by means of the bank of switches mounted on the sloping panel on the immediate left of the instructor. Likewise engine noises obtained from gramophone recordings are introduced into the cubicle by loudspeakers, and as already mentioned, radio interference in the form of actual signals and atmospheric add, not only to the difficulty of the wireless operator but they also further enhance the atmosphere of reality.

"TELEVISION COMMITTEE'S REPORT"

R. W. Hallows Replies to His Critics

IT was delightful to read in the June number of *Wireless World* the interesting criticisms by O. J. Russell¹ and C. W. Sheffield² of my article on the Television Committee's Report, which appeared in the previous issue. Mr. Russell makes some good points and deserves our gratitude for reminding us that one of the major difficulties in the way of high-definition television is the size and "fuzziness" of the spot. I am in complete agreement with him that electron optics must find a method of producing a small, sharply defined spot on the screen of the cathode-ray tube before the CRT, in anything like its present form, can provide television images of genuinely high definition. It is possible that the CRT will not give the final answer; as Mr. Russell says, the spot size of a mechanical system may be accurately defined.

There is, in any event, an immense amount of research and experimental work to be done and that is why so many people view with concern the prospect of devoting vast sums of money and some of the best brains in the country to the development of a 405-line system, which a committee comprising such acknowledged authorities as Sir Edward Appleton, Sir Stanley Angwin and Sir

Noel Ashbridge has stated to be satisfactory for an image of the order of 10×8 in., but inadequate for the large screen.

There are two important reasons why large-screen television must be a primary objective. The first is that the man-in-the-street wants it and may not become enthusiastic about television until he gets it. The second is that once it goes into partnership with the cinema, the success of television will no longer be in doubt for a moment.

You may prove to John Citizen that mathematically a 10×8 in. screen at 6ft. is of the same relative size as a 3ft. screen at 12ft. or as the full cinema screen seen from the best seats in the house: he will reply that it doesn't seem the same to him, anyway. He dislikes the small screen for much the same reason as he dislikes headphones: he feels cramped by both. Incidentally, I defy Mr. Sheffield to find in my article one word suggesting that "every television user has large rooms, a large family, or perpetually entertains large groups of friends." I merely recorded what so many people had told me. They don't like the small screen. Does Mr. Sheffield, by the way, really suggest seriously that the average living room is of 100 to 150 sq. ft.?

The pronouncements quoted by Mr. Russell on the number of lines theoretically necessary to give perfect images make inter-

esting reading. He does not give dates for those of Wikkenhauser, Traub and Gardiner, but since his reference is to Vol. 2 of the Television Society's *Journal*, the inference is they were made some little time ago. All departments of wireless have progressed along paths strewn with the dry bones of discarded theories and one wonders whether these statements are not in need of revision. Certainly no one who has seen 180-line or 240-line television would nowadays describe the images of the former as of "highly satisfactory definition sufficient for a public service," or those of the latter as leaving "no room for criticism whatsoever."

I am in the fullest agreement with Mr. Russell that few pre-war television receivers did real justice to the 405-line transmissions. There is every reason why those made now that the German war is over should be improved on the lines that he so ably suggests; but I still feel that it is a waste of time, energy and money to develop a nationwide 405-line service.

Mr. Sheffield accuses me of indulging in a variety of fallacies. Accusation Number Two (the one about large rooms) I have already shown to be a figment of his own imagination. Number Three concerns standards of picture definition. "The fact," he cries, "is that there are more picture elements in the 405-line

¹ "Television Standards," *Wireless World*, June 1945.

² "Television Fallacies," letter to the Editor, *ibid.*

"Television Committee's Report"—standard pre-war picture than in any 8mm., 9.5mm. or 16mm. home movies." May I refer him to Mr. Russell's view that under the best conditions a 16mm. projected image corresponds to about 700 lines in the centre and some 300 lines at the edges of the field? What are the figures for pre-war standard television images, if by "standard" he means not theoretically perfect images, but those actually produced by available receivers?

But in his accusation Number One he himself becomes *splendide fallax*, for he has failed to verify his facts and figures. I don't want to put words into his mouth, but could anyone read his second paragraph (which denies that the London area can be used as any sort of guide to the prospects of television) without forming the impression that this part of the country lagged a long way behind most other thickly populated areas in its enthusiasm for wireless right up to the outbreak of the war? "If," he says, "sound broadcasting had depended for its early success on this area, it would have taken another five years to get going." In my article I suggested that the response of the London Television service area to the stimulus of a 405-line service would be no bad indication of what might be expected in other parts. This area may conveniently be taken as the counties of London, Middlesex, Hertford, Essex, Kent and Surrey—London and the Home Counties. Reference to B.B.C. year books of the past will show whether or

not their inhabitants loitered whilst others ran.

The B.B.C.'s first system of 8 main and 11 relay stations was completed in 1924. The present regional system was in full blast in 1933. Here are figures showing the percentage of inhabitants holding receiving licences in 1931, 1932 and 1933.

Most Densely Populated Areas	Percentages		
	1931	1932	1933
London and Home Counties.. ..	11	13.8	15.5
Lancashire.. ..	8	11	13
Yorkshire	8	10	13
Staffordshire ..	6	7	9
Durham	3	4	5
Derby	6	7	9
Nottinghamshire	10	12	15
Warwickshire ..	11	13	15
Cheshire	5	7	8
Northamptonshire	13	14	16
Whole of England..	9	11	13

For 1938 the figures, the last detailed ones available to me, show the number of licences per 100 families; but, taking the accepted figure for England of 3.72 persons per family, they are easily brought into line with those for earlier years. They work out as follows: London and Home Counties, 20%; rest of London Region, 20.9%; West Region, 21.6%; Midland Region, 21.6%; North Region, 18.6%. If we take what we may call the "keenness factor" of London and the Home Counties as unity, that for West is 1.08, for Midland, 1.08, and for North, 0.93. Not much lagging there on London's part. And the London figure is a little above that for the whole country.

SIMPLE RESISTANCE MEASUREMENTS

ALTHOUGH multi-range meters have a scale for measuring ohms, upon some occasions this is not found satisfactory, either because the scale does not properly embrace the measurement needed; the part of the scale concerned may be too cramped. Furthermore, deflections are not equal throughout the scale; if the pointer comes to rest midway between, say, 500 and 1,000 ohms the resistance value shown is not 750 ohms but a somewhat lower value.

The simple hook-up shown in the diagram overcomes these difficulties. A potentiometer of about 500 or 1,000 ohms is connected across a battery of about 12 volts. The voltmeter should preferably have a full-scale deflection of 10 volts, and the mA. meter is a 1mA. model with shunts for 10 and 100mA. deflections.

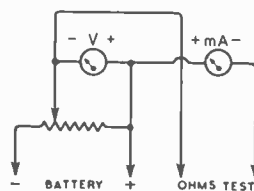

Method of using a voltmeter and milliammeter for resistance measurements.

Assume the meter is on the 1mA. range and a resistor connected to the ohms test points. The potentiometer is now adjusted from minimum to apply increasing voltage as shown by V. Now when 1mA. flows as shown by the meter the ohmic value of the resistor must be 1,000 times the voltage shown by V. For example, if V showed 4.3 volts R under test would be 4,300 ohms. (If the resistance of the 1mA. meter is more than a few ohms, on this range its resistance should be deducted from the value found for R, as it also is in circuit.)

For measuring higher resistance values the potentiometer is adjusted until 0.1mA. deflection is shown. R is then 10,000 times voltage shown by V. If 1mA. deflection is obtained with only a small voltage shown by V then the milliammeter can be set to the 10mA. range to obtain higher accuracy. R will then be 100 times voltage shown by V in ohms. With the meter set for 100mA. full-scale deflection the multiple will be reduced to 10. For example, with a voltmeter showing 0-10 volts, resistance values from 0-100 can be measured.

F. G. R.

Books issued in conjunction with "Wireless World"

	Net Price	By Post
FOUNDATIONS OF WIRELESS. Fourth Edition, by M. G. Scroggle	7/6	7/10
TELEVISION RECEIVING EQUIPMENT, by W. T. Cocking	10/6	10/10
RADIO LABORATORY HANDBOOK, by M. G. Scroggle. Second Edition	12/6	12/11
WIRELESS SERVICING MANUAL, by W. T. Cocking. Sixth Edition	7/6	7/10
HANDBOOK OF TECHNICAL INSTRUCTION FOR WIRELESS TELEGRAPHISTS, by H. M. Dowsett and L. E. Q. Walker. Seventh Edition	30/-	30/7
RADIO DATA CHARTS. Third Edition, Revised by J. McG. Sowerby, B.A., Grad. I.E.E.	7/6	7/10
RADIO INTERFERENCE SUPPRESSION, by G. W. Ingram	5/-	5/4
LEARNING MORSE. 335th thousand	6d.	7½d.
INTRODUCTION TO VALVES, by F. E. Henderson	5/-	5/4
RADIO WAVES AND THE IONOSPHERE, by T. W. Bennington	6/-	6/3

Obtainable from leading booksellers or by post from
ILIFFE & SONS LTD., Dorset House, Stamford Street, London, S.E.1

Angles on **BRIMAR PRESTIGE**



Your set will work at its best when you put Brimar Valves in the sockets. Their performance is perfect, their reliability supreme! Not always easy to get, but often available upon request.

BRIMAR

BVA

VALVES

STANDARD TELEPHONES AND CABLES LIMITED, FOOTSCRAY, SIDCUP, KENT.



CERAMIC *Pot* CAPACITORS

in

SERIES/PARALLEL COMBINATION

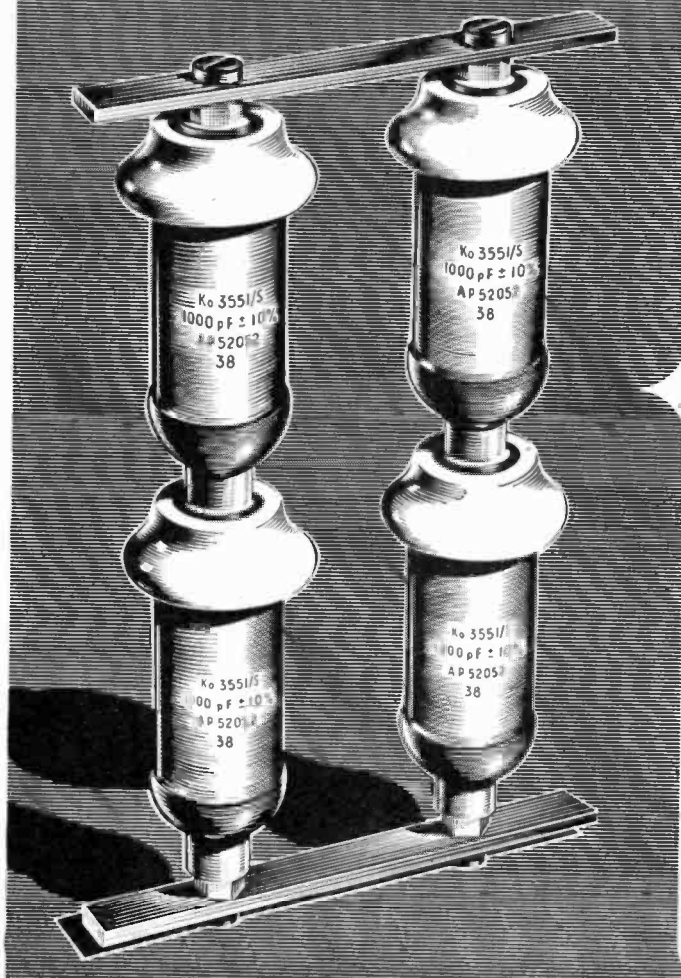

*extend the useful
range of voltage,
load and current . . .*

FOR

RADIO COMMUNICATION,

BROADCASTING,

TELEVISION,

NAVIGATION and

HIGH FREQUENCY EQUIPMENT

FOR INDUSTRIAL, MEDICAL,

& SCIENTIFIC PURPOSES . .

Full details on request.

UNITED INSULATOR CO. LTD. 12-22 LAYSTALL STREET, LONDON, E.C.1

Tel. : TERminus 7383 (5 lines) · Grams. : Calanel, Smith, London

THE PIONEERS OF LOW-LOSS CERAMICS

"VALVE VECTORS"

Some Criticisms—and the Author's Reply

DR. STURLEY'S article (*Wireless World*, May 1945) is an attempt to clear up a point which is presumably confusing to many students, but in my opinion he has only confused the point still further. The purpose of this short article is to explain why this is so, and to suggest what I believe is a correct and fruitful way of viewing the problem. I must make it clear that I am concerned only with the first part of Dr. Sturley's article, and not with the example with which he concludes.

The facts upon which we all agree are these. When an AC grid voltage E_g is applied to a valve, an AC anode current I_a is observed as a physical reality. To account for the existence of this AC current, an imaginary voltage μE_g is postulated inside the valve. The sign of this voltage is naturally chosen to give the correct direction of the observed AC current.

It is at this point that Dr. Sturley diverges from my view of the subject. His article says that μE_g produces an AC current I'_a , which is not the same as the actual AC current I_a , and which is in fact of opposite phase to I_a . Now, what is the student to make of this? He now has two AC currents in one circuit, in opposite phase, so that he may wonder (as I did) whether they add up to give zero; and—what is much more muddling—the second (imaginary) current is produced by an imaginary voltage which was invented solely to account for the existence of the real current.

I consider that this view of the matter is more than merely confusing; it is simply not true. There is a real (i.e., observable) AC grid voltage, a real AC anode voltage (if there is an anode load), and a real AC anode current. The voltage μE_g is fictitious, but the behaviour of the circuit can be accounted for by assuming that it exists. But there is no observable AC anode current of opposite phase to the real current, nor does the assumption of a fictitious

By D. H. PARNUM,
B.Sc., A.R.C.S., Ph.D.

reverse current make the action of the circuit any clearer.

I suggest that this confusion arises from a misinterpretation of the usual pictures, such as are shown in my Fig. 1, of E_g , μE_g , and I_a . E_g shows the grid voltage with respect to the cathode, and μE_g the generated voltage with respect to the cathode. I_a shows the AC anode current in relation to μE_g .

It is often said that Fig. 1 shows μE_g in "opposite phase" to E_g . Now when we say that two voltages are in opposite phase, we are usually talking of two voltages acting in the same circuit, and we mean that they oppose one another in the circuit. E_g and μE_g do not act in the same circuit, however; they do not interact together at all. They merely have a common point, the cathode; and the idea of "opposite phase" only makes sense when we refer both voltages to this common point. When we say that μE_g and E_g are in opposite

represent the usual idea of phase relation. I_a is the current produced in a circuit by the voltage μE_g acting in that circuit. We can say that I_a is "in phase" with μE_g . If we want to be rigorous, we can define this as meaning that I_a develops a voltage in the circuit impedance that opposes the applied voltage μE_g .

The difficulty, according to Dr. Sturley, is that the first half-cycle of μE_g is a "fall," and therefore the first half-cycle of I_a , which is also shown negative in Fig. 1, is also a "fall"; but since it corresponds to a positive grid voltage, it must be a "rise". Now a voltage cannot fall unless we specify some point in the circuit, from which we can reckon its polarity. In this case the point chosen is the cathode, and Fig. 1 therefore means that in its first half-cycle μE_g falls with respect to the cathode. A current, however, cannot "fall" with respect to the cathode, or any other point; it can only fall with respect to some reference level of current in the circuit. We can say, if we like, that the steady anode current provides such a reference level; but this has nothing to do with Fig. 1. The picture of I_a in Fig. 1 refers only to its relation with μE_g , the voltage producing it; the negative sign of the first half-cycle is merely a conventional way of showing the direction of I_a in relation to μE_g . If we want to know the relation of I_a to any other current such as the steady anode current, we cannot get it from Fig. 1; instead, we must consider the relation of μE_g to this current. The moment this is done, it is seen that μE_g during its "negative" half-cycle helps the HT battery, and so the "negative" half-cycle of I_a must help the steady anode current.

This discussion of Fig. 1 has, I hope, revealed what I believe to be a prime source of confusion—the idea that there is a phase relation of any sort between I_a and E_g . Dr. Sturley's diagram Fig. 2 (b), for instance, shows I_a and E_g

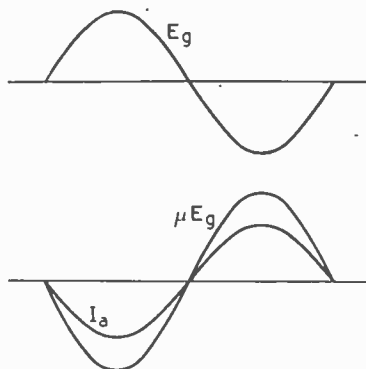

Fig. 1. Grid-voltage anode-current relationship.

phase, then (and I am sure that we shall all continue to say and think that they are), we mean just what Fig. 1 shows—that μE_g falls when E_g rises, both voltages being referred to the cathode.

Fig. 1 also shows I_a negative when μE_g is negative. This does

"Valve Vectors"—

as vectors on the same diagram, and they are said to be "in phase". Well, my Fig. 2 shows a voltage e and a closed current i , with a single common point at X; this represents exactly the type of relation between E_g and I_a . Is i "in phase" with e or not? Would it be any different if i had been drawn the other way round? Would the question have any less meaning if there were no common point?

The fact is that there is no meaning in saying that the AC anode current is "in phase" with E_g , and anyone who says there is will only create for himself the difficulty that Dr. Sturley is trying to explain. Even diagrams such as Fig. 1 can be dangerous, for the idea of "in phase" is quite different when linking E_g to μE_g , and μE_g to I_a . The right way to approach the subject is to drop all mention of any phase relation between I_a and E_g ; insist that the sign of I_a in Fig. 1 does not represent a rise and fall, but a direction in relation to μE_g ; and insist too that the sign of I_a in relation to the steady anode current must be obtained from the sign of μE_g in relation to the HT battery.

As a final comment on the material of Dr. Sturley's article, I cannot resist pointing out that

his Fig. 4 (a) shows the anode voltage with respect to cathode (E_{AK}) rising when E_g rises, which we all know is not the case. Presumably this is a draughtsman's error; but I have the feeling too that it is the kind of error that happens when one's argument is confused.

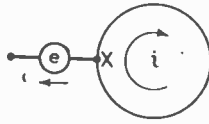

Fig. 2. Does this make the question of phase relationship any simpler?

I have the deepest respect for Dr. Sturley's ability and knowledge of the subject, which is far greater than mine; the idea that he does not understand what happens in a valve is laughable, and it is obvious that the approach of his article makes the matter clear to him. It does not make it clear to me, however, and I imagine that it does not make it clear to many other people. While, therefore, I think his article in itself has made the whole point more complicated, it will have served a very useful purpose if it stimulates people like myself (and, may I add, Dr. Sturley too?) to think more logically about the subject.

Dr. Sturley's Reply

I REGRET that Dr. Parnum should find my article on "Valve Vectors" a hindrance rather than a help, but I am not entirely to blame for that state of affairs. He holds that there is no phase relationship between cause and effect; viz., E_g and I_a . This is certainly an unusual position to take and it is not therefore surprising that my article appears confusing to him. We are talking entirely different languages. I assert with all the force of experience that Dr. Parnum is wrong when he states for a resistance-loaded valve that "there is no meaning in saying that the AC anode current is in phase with E_g ." Referring to his Fig. 2 the only shadow of doubt which can exist is whether the phase angle between e and i (controlled by e) is θ or $(180 + \theta)$ and the answer will depend on the convention

adopted. What is the poor student to make of Fig. 1, which shows I_a decreasing when E_g increases? A DC test will show him that the reverse is true, and it is just this impasse that my article seeks to prevent.

I had thought I had made clear that the fictitious current I'_a from the fictitious generator, μE_g , is not the real current. The latter, owing to the DC power source, is the difference between the DC current and I'_a , so that the real AC current component is 180° out of phase with the fictitious I'_a . I had certainly meant to imply that the fictitious and actual currents were manifestations of the same thing, and I still feel that the method set forth is the best way of tackling the problem. I could, of course, have treated the fictitious voltage in the way suggested by the *Wireless Engineer*

editorial of March 1940 with the fictitious current in the same direction as the DC anode current. This involves adding currents and subtracting the AC fictitious voltage from the DC voltage in order to obtain anode voltage instead of, as I do, subtracting currents and adding voltages. Personally, I consider the first method easier to grasp but naturally opinions will differ on this point.

Dr. Parnum is correct in assuming that the direction of E_g in Fig. 4a is due to an error of draughtsmanship on my part. E_g should have been shown in phase opposition to $I'_a R_o$.

K. R. S.

CAR RADIO

SOME interesting views on the future form of car radio equipment were expressed in a paper read before the Institution of Automobile Engineers on June 5th last by A. W. Martin, chief engineer of E. K. Cole, Ltd. After postulating the pre-requisites of really satisfactory car radio, the relative merits of the small self-contained receiver suitable for installing behind the fascia board and the multi-unit assembly in which only a small control unit needs to be accessible to the user, were discussed at some length.

During the subsequent discussion, the most controversial subject was the method of tuning to be employed in a car radio receiver. The issue was "free-tuning" versus "pre-tuning"; the last-mentioned was the system favoured by the author of the paper, on the grounds that programme selection by means of press-buttons or a rotary switch was less distracting of the driver's attention than searching for a station with the free-tuning type of control. All speakers stressed the safety angle, assuming apparently that no one, save the driver, would be able to take care of the radio set.

A plea, supported by several speakers, was made for provision of both systems of tuning in the one set, foreign travel being one of the reasons given for it. In his reply, the author of the paper pointed out that while such facilities could be provided they would add considerably both to the size and to the cost of car radio.

EXPORT TO HOLLAND

The Dutch firm Radio-Apparaten en Instrumentenfabriek Sinus, of 37/39, De la Reylaan, Zeist, Holland, invites offers from firms able to offer broadcast receivers for the Dutch market.

BRITAIN'S MONITORING SERVICE

Interception on the Grand Scale

STARTED by a mere handful of men in the late summer of 1939, at the request and on behalf of the Government, the B.B.C. Monitoring Service has grown into a highly organised professional news and intelligence service employing over 600 people whose task it is to listen to and record every important radio transmission from foreign countries.

Wireless World recently had the opportunity of visiting this modern Tower of Babel at Caversham Park, near Reading, where the staff of many nationalities forms a human conveyor belt perpetually passing information gleaned from the world's broadcasts.

Although the monitoring station is situated in a pleasantly secluded spot it is not entirely free from man-made electrical interference. It was therefore decided to erect an array of receiving aerials some three-and-a-half miles from the station to ensure, as far as possible, good reception. The RF current from the rhombic and Beverage aerials is fed by 38 lines to the main listening station where there are also a few subsidiary aerials.

The lines from the distant aerials terminate at the Engineering Measurement Room, which is the nerve centre of the station.

In the main listening room there are some forty receivers, many of them well-known broadcast sets, whilst others are Service types. These are operated by the monitors who are expert linguists, some of them having a working know-

ledge of as many as ten languages. During their eight-hour duty period they listen with headphones to scheduled transmissions of news from foreign countries. Whilst listening to the broadcasts they take notes and, to ensure complete accuracy when an item is quoted, the monitor records the whole transmission on cylinders similar to those used on an office Dictaphone.

As soon as the monitor has received a complete transmission he (or she) takes his notes and cylinders to those whose task it is to select from the plethora of words recorded—about 1,250,000 a day—that which, from their training and knowledge, they know is needed by the many Government departments and broadcasting services served.

Some of the items monitored may be required for re-broadcasting immediately in one of the B.B.C. services. In this case the monitor can switch through to the

Engineering Room and have the item automatically recorded on discs. These can be transmitted by line to Broadcasting House for incorporation in a programme.

In addition to the monitoring of definitely scheduled transmissions, there is maintained a listening watch so that stray transmissions are noted.

In addition to voice transmissions there are also many news services in morse which have to be monitored. These are principally from overseas news agencies. As is the normal practice in morse listening the monitors in this section take down the material direct on typewriters.

Another source of news is provided by Hellschreiber radio-printer transmissions. The apparatus, which is of German design, is to wireless what the teleprinter is to land-lines. Hell-



General view of the main listening room showing some of the forty receivers.

SACHEN DES ZEHMALIGEN PROPAGANDAMINISTERS
SACHEN DES ZEHMALIGEN PROPAGANDAMINISTERS

Reproduction of tape from the Hellschreiber printer.

Britain's Monitoring Service—schreiber services are now employed by the U.S.S.R., Spain, Norway, France and Yugoslavia, although originally the apparatus was used exclusively by Germany. An elaborate Hellschreiber organisation was used by the enemy for instructions to his network of newspapers and broadcasting units all over Germany and occupied Europe. The B.B.C. secured one and, later, more of the receivers and was able to monitor fully both Goebbels' instructions and news.

As in the case of the material received by the "voice" monitors all material from the morse and Hellschreiber rooms is sifted by a supervisor who indicates the appropriate treatment. This may be for the "flash" service and/or the "Daily Digest of World Broadcasts."

If the former, then it is sent by teleprinter to all, or a selection of, the nineteen out-stations, lines to which are in duplicate. These out-stations, which can be selected on

a control panel, include No. 10 Downing Street, the War Cabinet, Admiralty, War Office, Air Ministry, B.B.C., American Broadcasting Station in Europe, and the U.S. Federal Communications Commission. The last mentioned also supplies the monitoring service with information received by its own monitoring station in the Western Hemisphere.

Special monitoring stations maintained in Egypt, India and Italy also supply the monitoring service with information which might not readily be received direct in this country.

The "Daily Digest" already referred to is a 100,000-word summary of the 1,250,000 words which, up to the German surrender, were daily received. This digest is daily circulated to about 600 subscribers. In addition, there are miniature reports issued in several foreign languages for special purposes.

It is hoped to give a more detailed description of the station's equipment in a future issue.

to mark off E ten small squares above B and to join OE. Now try the problem mentioned above: find R when R_1 is 8,000 ohms and R_2 700 ohms. The straight edge laid between 8 on OA and 7 on OB cuts

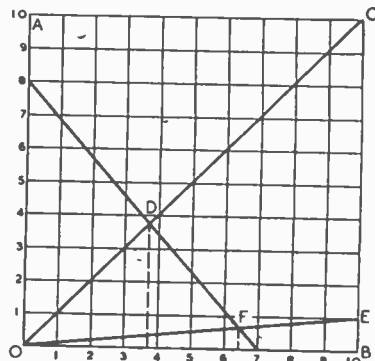

OE at F. Dropping vertically from F to OB we find that the reading is a little under 650 ohms—say 645. Work it out and you will find that the graphical solution is not so very far wrong.

□ □ □

Wonderful Licence Figures

AMAZING how the number of wireless receiving licence holders has not merely been maintained since the outbreak of war but actually increased by more than three-quarters of a million. Just before the war began the total was 8,947,570; now it is 9,710,850. And that despite the facts that millions of men and women were in the Forces and that vast numbers of houses were destroyed or rendered uninhabitable by the effects of bombing. In spite, too, of the shortage of new receivers and of the difficulty of getting old ones serviced. These figures are an eloquent testimony to the way in which our radio industry has managed not only to achieve the impossible in meeting the enormous demands of the fighting forces, but also to supply a trickle of new sets for civilians and to provide the spare parts, the labour and the skill required to keep old sets running. Another rather interesting point is that the useful life of a wireless set must be a good deal longer than most of us imagined. I wonder what answer you'd have given if, six years ago, you'd been asked: "Suppose that during the next five years less than a million new wireless sets are made or imported, that comparatively few spares are available and that most of the skilled servicemen are withdrawn; how many wireless sets will be in working order in this country at the end of that time?" My guess, I freely admit, would have been that well over half of them would have packed

RANDOM RADIATIONS

By "DIALLIST"

A FELTHAM reader very kindly sends me a variation of the graphical method of calculating parallel resistances. It is illustrated in the accompanying drawing. OA, OB are scales drawn on good graph paper and OC exactly bisects the angle AOB. Let us suppose we need to find R when 8,000 ohms and 7,000 ohms are in parallel. Lay a straight edge from 8 on the vertical scale to 7 on the horizontal and mark where it intersects OC. A vertical or horizontal straight line from the intersection D to either scales enables R to be read off. Even on indifferent graph paper the value is easily seen to lie between 3,700 and 3,750 ohms, being rather closer to the latter than to the former: say 3,730. The calculated value of R is 3,733.3. The system also works backwards, so to speak. For example: what parallel resistance must be used to reduce 500 ohms to 300? Lay the straight edge between 5 on OB and 3 on OC and mark where it cuts OA. The reading is 7.5, or 750 ohms. The proof is quite straightforward and is on much the same lines as that given for the original graphical method. When I say

"original," by the way, I don't mean that the method previously described was novel. Far from it; systems of that kind are probably of quite ancient lineage.

A Step Farther

Most graphical methods of evaluating parallel resistances (and of course series capacitances) have the serious failing that they can deal only with quantities of the same order. You can quickly get the resultant of two parallel resistances so long as *both* are measured in units, tens, hundreds, thousands, ten thousands and so on of ohms. But you're stumped when a combination such as 8,000 ohms and 700 ohms turns up. Whilst playing with the system illustrated it occurred to me that it could readily be adapted to meet such cases. The reason why values can be read off either scale DA or scale OB is that the angle COB is of 45 deg. and $\tan 45 \text{ deg.}$ is 1.0000. One scale can be made to have ten times the value of the other if OE is drawn so that $\tan EOB$ is 0.1000. And that is a very easy matter on graph paper, for all that you have to do is

up before the period was over. Even with the stimulus of the wartime hunger for news the fact that the great majority of the old sets were kept in use is an astonishing business. People, of course, didn't worry much about the quality of reproduction so long as the news and the great wartime broadcast speeches were intelligible. The surprising thing is that reproduction was possible with apparatus much of which must have been from six to ten years old.

□ □ □

FM

FREQUENCY - MODULATED broadcast transmissions would, I believe, have considerable success in this country. I was glad, therefore to read in the B.B.C. Year Book Sir Edward Appleton's forecast that if and when UHF relay stations are added to our present system some, at any rate, are certain to be of the FM type. The success of FM in the United States has already been phenomenal, even though such services are still confined to a very small number of localities. At least half a million FM receivers have been installed and—rather amazingly—people with an eye to the future have been buying them for some time in places which are as yet without an FM service. Two things have made FM popular with Americans: first, the splendid quality of reproduction obtainable with its high-fidelity transmissions and secondly, the freedom which it ensures from both natural and man-made interference. I should very much like to see FM used for the speech accompanying vision transmissions in this country. What would be still better would be the use all day long of the television sound channel for sending out, say, the national programme. I am sure that the sales of televisors would be enormously increased if the intending purchasers knew that their loudspeakers would provide high-quality interference-free reproduction of the ordinary programmes.

□ □ □

Awkward Bits and Pieces

HAS it ever struck you that some of the electrical fittings on the market must have been designed by people who took a sardonic delight in making them just about as pernickety and as time-wasting as they could be made for the unfortunates who have the task of fixing them up? Switches, wall sockets and lampholders are amongst the worst offenders. There are, of course, many of excellent design; but in these days you generally have to take what you can get and make the best of it. Just how annoying some of them can be was brought

home to me the other day when I was fixing up a wall socket to supply power for a wireless set in a room where previously there wasn't one in a suitable position. This socket had miserable little binding screws for the wires, so placed that to get at them properly would have needed a round-the-corner screw-driver! To make matters worse, they were a loose fit in the female threads and when I was trying to secure the wires one of them fell out. To get it in again was a fiddling and exasperating job. Some very special and unpleasant kind of purgatory should be reserved for those who design these horrors. I trust, anyhow, that all the naughty words used by maddened victims of such things are chalked up by the Recording Angel, not to their account but to the designer's.

□ □ □

Television Wavelength

IT was perhaps a little surprising to find in the Television Committee's report no recommendations about the wavelengths used for television transmissions. Those in use at present do not seem very suitable for the purpose, since they are very prone to interference from car ignition systems. Nothing can probably be done about the Alexandra Palace station and in any case existing sets in its service area are designed for its present wavelengths.

But it might be no bad idea to see if more suitable wavelengths cannot be found for the projected provincial stations. I'm afraid I take rather a gloomy view of the interference position in the days to come. The Committee's recommendation that the Postmaster-General should be given powers to deal with it won't get us anywhere unless (as is most unlikely) those powers are strong and ruthlessly used with no pandering to vested interests. What I foresee is some rather flabby legislation on the subject and probably very little real improvement for a good many years.

EXPORT CONTROL

AMONG the products affected by the relaxations in the export licensing control, which were introduced on June 11th, are: receivers, resistances, valve holders, microphones, loudspeakers, ceramic components, echo sounders, and accumulators. Full details of the present control will be found in the Order, S.R. & O., 1945, No. 576, which is obtainable from the Stationery Office, price 6d.

OUR COVER

AERIALS of the National Broadcasting Company's FM and television stations mounted on top of the Empire State Building, New York, are illustrated on our cover.



A REHEARSAL.—To give members of the A.T.S. experience in operating the recorders for "vocal letters" they were recently installed at a cinema in Staines, Middlesex, where families of soldiers serving overseas recorded messages. The 5 in. discs are either metal- or cardboard-based, with a nitro-cellulose coating. It is interesting to note that an ordinary telephone handset is used; presumably because of its familiarity, it is considered to be less frightening than the usual type of stand microphone. The vocal letter scheme, which is already in operation in the Middle East and on the Continent, may shortly be extended to men serving in India and Burma.

TELEPATHY — Or Should it be Radio-Telepathy?

SOME apology is probably needed for discussing or even mentioning telepathy in *Wireless World*. Most of its more serious readers probably regard telepathy as a very shady subject. There are, they think, two forms of telepathy. One, with which the name Zadig is associated, was obviously a trick of some sort, for no one expects anything else in a music-hall. The other still goes on in shaded suburban rooms, with no controls and no safeguards. Tremendous efforts have been made to discredit telepathy by the popular front of students in this field. The housemaid's weeklies, with their touching stories of remarkable effects, make most people believe that telepathy, like history, is bunk.

Distinct from all this, serious scientific experimental work is being carried out under properly controlled conditions. Unfortunately this work is apparently not becoming known to those who understand "action at a distance." The idea of producing an effect at one place by doing something at another is familiar to every radio engineer, but the philosophers who interest themselves in this work on telepathy do not understand the principles of propagation of electromagnetic waves. Indeed, the Baconian treatment of a problem seems quite unfamiliar to them. It seems desirable, therefore, to discuss briefly the work which has been done on telepathy, to mention other apparently unrelated work on electric currents in the human nervous system, and to consider whether these two fields are in any way related.

I must begin with a disclaimer. I cannot vouch for the accuracy of the experiments described, although I find it impossible to believe that there has been any misrepresentation. I have no dogmatic faith that the radio and telepathic fields are in fact related. I say only that certain men say certain things, I speculate on their interconnection and I suggest that here is a fruitful field for exploration by the radio engineer.

By "RADIOPHARE"

In a recently published book ("Telepathy": Whateley Carrington: Methuen) it was denied that telepathy can be explained on a radio basis. In this article a radio engineer gives some support to the opposite point of view.

Just over ten years ago a book* was published which really put telepathy on to the scientific map. In this book the author describes work carried out at an American university with a large number of subjects. The work is, in some ways, very dull and matter-of-fact, and it is this lack of emotional content which gives it its interest and value. The object of the experiments was to determine whether the subject, who was usually an undergraduate, could obtain a knowledge of a particular fact which was not directly accessible to him. A special pack of cards was used,

Rhine describes three different procedures. In one, the cards were taken from the pack by a second person, who looked at them and then put them down. The subject wrote down what he thought the card was, by what might be called guided guessing. A second procedure was adopted to determine whether the guidance depended on the second person knowing what was on the card face, which would have involved telepathy. The cards were taken from the pack face down, so that the dealer had no knowledge of the marking. Clairvoyance would explain success in this series of tests, but so would hyperæsthesia on the dealer's part. Hyperæsthesia is a greatly enhanced amount of sensory perception, and is often regarded as an explanation of common uncontrolled telepathy. If the dealer unconsciously recognised cards by their backs in the second series of tests, success might have been due to tele-

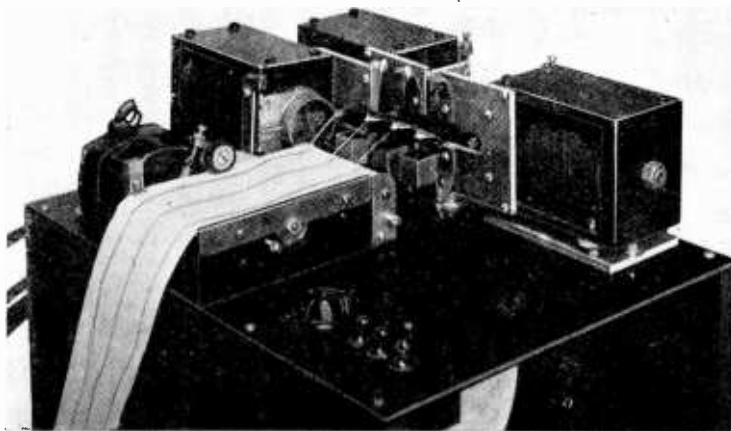

It is suggested in this article that there may be some connection between telepathy and the well-known phenomenon of generation of electrical impulses in the human brain. This photograph shows the recording mechanism of an Ediswan electro-encephalograph, an apparatus devised for investigating the nature of these impulses.

made up of five each of five different cards, each marked with a simple code mark, such as a cross or a star. The subject under test had the task of guessing the mark on the face of each card without seeing it.

* *Extra Sensory Perception*. J. B. Rhine.

pathy. In the first series, the dealer might have muttered the card mark very quietly, and the subject could then have "hyperheard" this and become aware of the marking without knowing that he had heard the answer. A third series of tests was therefore

carried out, in which the subject wrote down in order the markings on an untouched pack. Only clairvoyance would explain success in this test.

Rhine's experiments are easily amenable to statistical study, but they require more care than might be thought at first. For proper examination the cards must be arranged in a completely random way. A shuffling machine was used to eliminate any systematic order which might result from ordinary methods of shuffling. It would perhaps have been better had the packs been arranged in accordance with a scheme based upon a table of random numbers, using a section which had been tested for randomness.

Better than Guesswork

The results were not spectacular, for the average number of successful guesses was about eleven per pack. To the statistician the results show a significant deviation from the number of successes which would be obtained by chance alone. Care is needed in this analysis, for most gamblers have an occasional run of luck, which at first would seem to indicate special knowledge.

Some of the subjects showed remarkable accuracy in these tests. In some experiments the subject was not in the same room as the pack of cards, and results were obtained over quite considerable distances. It is interesting to compare these results with those of the spiritualists. The Rhine school has shown that a statistician can detect evidence that a very simple idea can sometimes be transmitted when the receiver is expecting it. The level of the triggering impulse is just above noise, in fact, and there are quite a lot of misfires. In these experiments the actual amount of intelligence transmitted is very small indeed.

More recently work by Soal and Goldney has given more evidence for telepathy. This work, which was on similar lines, was even more vigorously controlled than Rhine's. It raises other issues which will interest the reader of J. W. Dunne's books, but which do not concern us here.

There is other experimental evidence, and work is continuing. Meanwhile, a mystical explanation

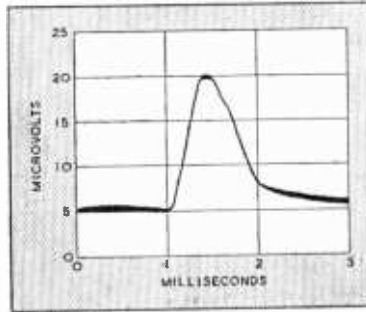

A single impulse in a single nerve fibre. From "Journal I.E.E."

tion of the results in being given, though not by the actual experimenters. This explanation appears to be a mere wrapping-up of the subject into a neat cloak of words. Writers suggest that telepathy works by association; that there is a common subconscious. This seems to mean no more than saying that we can explain the working of a wireless set as being "by radio." Occam's Razor can be invoked to clean the subject of this nonsense.

So much for the facts of telepathy. Now we shall consider some rather more orthodox work which is also rather outside the field of most radio engineers. The electrical phenomena in the human nervous system and the brain were described in a recent paper† read before the I.E.E. Much of this paper is devoted to descriptions of circuits and apparatus, but the authors give a simple account of the electrical phenomena which their apparatus is intended to amplify and record. It would appear that the most fundamental thing which a living cell does is to act as a battery. Life without electrical charges would seem to be a contradiction in terms. Each cell builds up a steady potential difference of about 50 mV with respect to its environment, and the cell interior is negative in polarity. If the cell is injured, the membrane enclos-

(Concluded on page 216)

† "Amplifying and Recording Technique in Electro-Biology, with special reference to the Electrical Activity of the Human Brain." Parr and Grey Walter. J.I.E.E. Vol. 90. Part III. No. II. September 1943.



THE TANNOY LOUDSPEAKER SOUND SYSTEMS

save valuable executive time, increase production, and ensure greater general efficiency.

Remember, too,

TANNOY

HIRE

MAINTENANCE

ensures equipment being always at 'concert pitch.'

TANNOY
The Sound People

TANNOY is the registered trade mark of equipment manufactured by

GUY R. FOUNTAIN LTD.
CANTERBURY GROVE, WEST NORWOOD,
LONDON, S.E.27 and BRANCHES

'Phone: GIPsy Hill 1131.

The Largest Organisation in Great Britain specialising solely in Sound Equipment

Telepathy—

ing it no longer protects it completely and the inside of the cell rises to "earth" potential. When something is happening to the cell, for example if it is a nerve cell and a message is being passed, the membrane breaks down and a leakage current flows. Ions from other parts of the membrane migrate to close the leak, and a further breakdown takes place at the point from which they have migrated. The breakdown thus travels along the nerve. The actual electrical effect takes the form of an impulse which in the human body has a peak amplitude of about a millivolt and a duration of a millisecond. Both amplitude and duration are independent of the stimulus which started the message on its way. The actual form of the impulse is shown in the figure (Fig. 2 of the paper). It can be seen that the front is quite steep, with a slow die-away.

Brain Currents

These currents form what might be called the external communication system of the brain and convey all the messages which pass between the sensory organs and the muscles, and the brain. In addition to this external system there is a complex flow of currents inside the brain. Voltages of from $5 \mu\text{V}$ to 1 mV , at frequencies from 1 c/s to 50 c/s can be detected in ways described in the paper. One of these current systems, the so-called alpha rhythm, is an irregular set of waves of about 10 c/s frequency of up to $100 \mu\text{V}$ amplitude. This is the "stand-by" output of the brain, for it is at a maximum in a brain at rest. During sleep, however, it disappears, suggesting that sleeping is quite hard work. Dreams are marked by a burst of alpha rhythm activity. Other characteristic waveforms are found, some of them indicating specific abnormal conditions. The paper referred to gives a full description, with references to the original papers. It is sufficient for our purpose to know that the communication system between the sensory organs and the brain is by means of impulsive electric currents. The experiments described are all at low frequency.

The reader who has persevered

so far may ask why these two fields of enquiry have been linked together in a single article. It is here that I leave the solid ground of experimental results and embark on speculation. The phenomena of extra sensory perception in its most general form involve the introduction of apparently sensory effects into the brain without there being any initial stimulus of the senses. What does this mean in simple terms? Surely, that the impulses begin somewhere along the nerve channel, not at the sensory organ at the end. Thus, if impulses are started in the nerve system from the eyes, the brain will think that something is in sight, that light is falling on the retina. This effect is analogous to the picking up of power-frequency signals in a telephone open-wire circuit. To the listener who is not aware of this possibility, the 50 c/s tone appears to come from the other end. Cross-talk, in this sense of the excitation of a message current at a point along a nerve, seems to be an explanation of some of the effects.

The fact that some people are more sensitive than others is also of interest. It is possible that in some people the margin of safety against breakdown of the insulating membrane is very small, so that a breakdown is easily initiated. The threshold might be expected to vary with the state of health of the subject, as Rhine's experiments suggest. This will not affect the actual message reaching the brain, for once breakdown occurs, the standard impulse will be transmitted.

Radiation or Induction?

All this reasoning is directed towards the explanation of extra sensory perception. Telepathy is a slightly different affair. In both, however, there is the problem of how the energy is actually transmitted. Two explanations are feasible. One simple one is that the impulsive currents excite the actual cells to resonance at very short wavelengths, each cell acting as a half-wave dipole. The resulting radiation is picked up by other people having the same cell length, who are consequently in tune, and produces impulsive currents in their nervous systems. There are a lot of snags in this

theory, but experimental tests should not be impossible, for low levels only are involved, and test oscillators could be made for these frequencies. The alternative explanation is that direct induction fields at the alpha rhythm frequency are responsible. Here, again, people having identical characteristic frequencies should be in tune and particularly susceptible to mutual thought transfer. The frequencies involved are particularly easy to detect and record. It would be interesting to know whether the electroencephalograph had been used in telepathic experiments.

Practical Uses

So much for speculation. There is real advantage to be gained from a study of telepathy, although this is not fully realised. Modern technology is becoming very complicated. Most of us have enormous gaps in our education and knowledge. If we are radio engineers we know far too little mathematics and physics and chemistry. Future research must be based on the work of teams, and if a means of establishing telepathic relationships between members of a team can be evolved, a new era in research will begin. No longer will communication difficulties hamper the working of a team. The ideas of one member will be introduced directly into the mind of another, perhaps having passed through a frequency changer. Any problem will then have several minds working on it both simultaneously and together. That some form of group mind is possible is suggested by the behaviour of flocks of birds and the swarming of bees. Nor would such a development involve a degradation of the human intellect. Rather the reverse, for one could become a specialist in several different things by becoming a member of a group of specialists.

The scientific method is being applied to these affairs which in the past have attracted only the unscientific. There is much to be done, but the possibilities are enormous. Probably, as the facts accumulate, the theories will become less splendid. I think, however, that the future of telepathy may be in the study of radio-telepathy.

WORLD OF WIRELESS

AMATEUR LICENCES

As a result of discussions between the Radio Society of Great Britain and the General Post Office, arrangements have been completed whereby applications can now be made for the re-issue of full transmitting licences to those who held them before the war.

It must not be inferred from this that licences are to be reissued immediately. The purpose of these arrangements is to assist the G.P.O. by giving the department concerned as much time as possible for the work involved.

Pre-war holders of full licences should make formal application to the Radio Branch, W2/6, Engineer-in-Chief's Office, Alder House, G.P.O., London, E.C.1, giving particulars of the former licence. These should include the name of the licensee, address of station, call sign and the address to which all future correspondence should be sent. It is pointed out that no other information is required in the first instance.

Applications should not yet be made by pre-war holders of artificial aerial licences or by those who have not previously held licences.

Transmitters who have changed their address since their apparatus was impounded at the outbreak of the war are reminded that they should, as soon as possible, notify the Radio Branch, W2, Engineer-in-Chief's Office, G.P.O., E.C.1, of the address to which the apparatus should be sent. It is unnecessary to submit a detailed list of the impounded apparatus.

No arrangement has yet been made regarding a release date of the impounded gear.

The fact that transmitters have been heard during the past few months using G7 call signs has caused some misgivings. We are informed that these stations, apparently working as amateurs, have in fact been serving a special purpose for which they received official authority. The working of this special service has now been suspended.

FAR EAST COMMUNICATIONS

With a view to re-establishing telecommunications in the Far East, Col. H. J. Wellingham, a senior official of Cable and Wireless, is visiting India, Burma and Ceylon for discussions with military and communication officers.

The Japanese occupation temporarily deprived Cable and Wireless of twelve stations, including the main supply depot and traffic junc-

tion for the Far East and Australasia at Singapore.

To supplement the direct wireless beam between London and Melbourne, C. and W. has established relay stations at Colombo and Barbados, and a further relay station has been erected at Perth by Amalgamated Wireless (Australasia).

Since the beginning of the Pacific War the Indian Radio and Cable Communication Co., an associate of C. and W., has opened direct wireless circuits with Melbourne, Chengtu, New York, and a circuit between New Delhi and London. A direct phototelegraph circuit with London is also operated by the company from Bombay.

RADIOLOCATION

ALTHOUGH *Wireless World* has been able to describe the basic principles of radiolocation, it has not yet been permissible to discuss practical details of the apparatus used. But, as we go to press, it is understood that authority for a joint Anglo-American release of more information is being arranged for the near future. It is hoped that we may be able to publish these details in an early issue and also to describe individual contributions of the British wireless industry.

TELEVISION RELAY

A SYSTEM for transmitting television from Washington to Philadelphia has just been put into operation by Philco. The distance of 152 miles is covered with the help of four intermediate relay stations, each with 40 W power and roof-top aerials.

TRIFURCATION

SIR IAN FRASER asked in the House if, in co-operation with electricity undertakings, the Postmaster-General will organise research to ensure that electricity, telephone and a number of radio programmes can be taken to villages and remote farms on the same poles, or even the same wires, so as to reduce the cost of these services and make them universally available.

In reply, the P.M.G. said: "Use is already made of the same poles for electricity and telephone wires to a limited extent. . . . Much information is already available in the Post Office with regard to the possibility of providing electricity, telephone service and radio programmes over common line plant. While this would be technically practicable with suitably designed plant, the evidence available shows that there would be

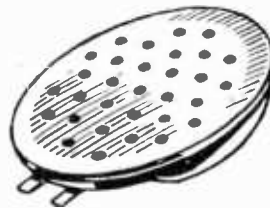

H.A.5 DEAF-AID CRYSTAL MICROPHONE.

ASTATIC will be ready to serve you again with high quality piezo-electric devices when the 'All-Clear' of Victory sounds. Astatic deaf-aid microphones can be supplied only if Import Permits are established. Model H.A.5 illustrated is used as standard by America's leading hearing-aid instrument makers.



THE ASTATIC CORPORATION
CONNEAUT, OHIO, U.S.A.
and
TORONTO, CANADA.

Exclusively Represented by
Frank Heaver Ltd. Kingsley Road
Bideford, N. Devon

SOON
CRONAME

Designing and
Engineering

will again be a factor in the plans of far-sighted manufacturers of electronic equipment. From building precision parts for wartime devices the Croname group will turn to the processing of mechanical and decorative items for the electronics industry.

A place in the Crowe schedule has meant attractive, practical, saleable merchandise to many. Our facilities may be valuable to you.

Dial Scales,
Tuning Mechanisms,
Printers, Resistances,
Precision Controls, Knobs.

Exclusively Represented in
Great Britain by

FRANK HEAVER LTD.
Kingsley Road, Bideford,
N. Devon.

Croname Incorporated

(Crowe Home Plating & Manufacturing Co.)
CHICAGO, ILL. U.S.A.

World of Wireless—

no economy over the existing methods of providing the services separately."

WHAT THEY SAY

MISAPPLIED ELECTRONICS.—Unfortunately electronics has been over-publicised. . . . To market an electronic device which is no better and does no more than its mechanical or electrical competitor of olden days would also result in discredit to industry even if the use of vacuum tubes in the device gives it an enhanced sales appeal.—*Paul G. Weiller in "Electronics."*

MALNUTRITION.—The next step is to decide upon the nature, size and management of foreign broadcasting—now in danger of becoming the forlorn and undernourished child of the B.B.C.'s home and empire services.—*"The Times."*

BOON OR BANE?—It is very difficult when any new discovery is made to foresee whether it would be used at all and whether it would be beneficial or dangerous to mankind. . . . If one took Radar. . . . At what stage would an international scientific committee be expected to intervene in the case of wireless waves—when Clerk Maxwell predicted them more than 60 years ago, or when Hertz proved their existence a few years later, or when Marconi showed they could be put to commercial use, or when we employed them to save ships at sea at the beginning of this century, or when they gave us broadcasting 20 years ago?—*Lord Cherwell in the House of Lords.*

POOLED RESEARCH.—It is desirable that the entire Empire and Commonwealth should combine their research activities. I would therefore urge the formation of a British Commonwealth Research Association as a fount of knowledge on all telecommunication matters



G. W. GODFREY, who has been appointed Radio Sales Manager of E. K. Cole. He has been in the industry since 1923 when he joined the Sterling Telephone Co. During the war Mr. Godfrey has been with Ultra Electric.

and of such power and pre-eminent character as would naturally draw to it Empire and Commonwealth, as well as foreign countries, for consultation and mutual assistance, thus combining all research resources into one co-ordinated whole without interfering with the autonomy and prerogatives of the component parts.—*Sir Alexander Roger, K.C.I.E., chairman of the Automatic Telephone and Electric Co.*

PERSONALITIES

Sir Ernest Fisk, founder of Amalgamated Wireless (Australasia), and until recently its Chairman and Managing Director, has arrived in this country. He has already taken up his duties at E.M.I., of which he was appointed Managing Director last November.

H. Warren has been appointed Managing Director of the British Thomson-Houston Co., on the retirement of H. Sporborg. He joined the company in 1911 and was appointed to the engineering staff in 1913 and became chief of the Research Laboratory in 1929. He was elected to the Board as Director of Research in 1938. Mr. Warren, who is 53, is a member of the Government Radio Research Board.

OBITUARY

It is with regret we record the death of **F. E. Collinson**, who founded Colvern, Ltd. He died at Chingford on May 16th last.

IN BRIEF

Valve Ban Lifted.—The Postmaster-General has announced that the restriction on the acquisition and sale of radio valves capable of an anode dissipation exceeding 10 watts was withdrawn from May 10th and that valves of this description may now be bought and sold without permit.

Technical Training.—Speaking recently, when Minister of Education, Mr. R. A. Butler stated that the shortage of radio technicians at one time presented a serious problem. In 1940 there were only 800 places available for them in technical colleges, yet by VE-day some 70,000 radio mechanics for the three Services had passed through their hands.

Marconi Men's Record.—Since the beginning of the war 39 radio officers of the Marconi Marine Service have received decorations for gallantry, 84 have been officially commended for gallant conduct, 2 have been mentioned in despatches and 18 were also awarded Lloyd's War Medal for bravery at sea.

Members of the U.S. Federal Communications Commission have been on a visit to this country.

Channel Islands Radio.—Stories coming from the Channel Islands since their liberation show that great ingenuity was shown by the inhabitants in maintaining broadcast reception during the German occupation. During the latter months of the war, improvised crystal sets were widely used. The owner of an Ekco mains receiver reports that he used his body capacity

as an aerial, while another member of his household kept a look out. To evade German searchers, the set was at one time buried in his garden and then hidden under a pile of damp wood.



SIR GEORGE E. BAILEY, C.B.E., who] became Chairman of the Metropolitan-Vickers Electrical Co., in March 1944, has now been appointed Managing Director of Associated Electrical Industries.

Burma News.—Three Cable and Wireless telegraphists have been seconded to the Army to go into the forward area of South-East Asia Command with mobile wireless sets in order to speed up the transmission of news. War correspondents' stories will be radioed back to base stations and re-transmitted to their destinations.

San Francisco Television.—The high lights of each day's activities at the San Francisco United Nations Conference are filmed and flown to New York, and televised from the National Broadcasting Company's New York Station, WNBT, the following night.

B.B.C. Short Waves.—The short wavelength used by the B.B.C. for the Home Service has been changed from 48.54m. (6.18 Mc/s) to 48.43m. (6.195 Mc/s), the call sign of which is GRN.

Car Radio.—A new company, Radiomobile, Ltd., has been formed jointly by the Gramophone Co. and Smith's Motor Accessories for the manufacture and servicing of car radio equipment. Among the directors are Sir Ernest Fisk, C. W. Nichols, F. B. Duncan and C. S. Agate.

Film Industries Apparatus.—In the advertisement of Film Industries in our June issue, incorrect prices were given for the MC microphone, horn speaker and cone speaker. The correct prices are £5 15s., £13 10s. and £4 5s. respectively.

Institute of Physics.—At the Annual General Meeting of the Institute, held on June 4th, the following officers were elected for the year commencing October 1st next:—President, Sir Frank Smith; Vice-president, Prof. A. M. Tyndall; Hon. Secretary, Prof. J. A. Crowther.

Institute of Electronics.—North-West Branch of the Institute is holding a meeting at 6.30 on July 27th, at Reynolds Hall, College of Technology, Manchester, when Dr. R. Feinberg will lecture on "Rectifiers and Inverters."

Letters to the Editor

Radiolocation Pulses • Component Production • Biological Amplifiers

Radiolocation

YOUR February issue, page 60, points out that Radar or Radiolocation was first put to practical use by the English Armed Forces. The first report, for public consumption, on basic radar principles appears in the same issue, page 34. Because England was the leader in this field when radar was most needed it seems especially unfortunate that the error to be found on page 36 was allowed to pass.

The diagram, Fig. 4, and accompanying explanation (col. 3, lines 17 to 24) constitute an unworkable system. One pulse of RF energy must leave the transmitter, travel to the target, and return to the receiver before another pulse is transmitted, since the radar operator has no way of telling which return pulse he has received. This may be further explained by reference to Fig. 4. Suppose another target were present at Point P_3 . This would reflect pulse P_3 back to the receiver A_2 before pulse P_2 arrives. Since the pulses have identical shape and may or may not have identical amplitudes, the operator cannot tell the difference between them. Therefore he may assume that P_3 is P_2 and thus obtain an incorrect range reading.

I feel sure this point has confused some of your readers, who are not familiar with the fundamental concepts involved. It is to be regretted that such an error should be missed in an otherwise excellent explanation.

R. L. BURTNER.
Princeton, N.J., U.S.A.

Dr. R. L. Smith-Rose, author of the original article, writes:—

I AM indebted to Mr. Burtner for his communication, and must say at once that I am in complete agreement with his comment. The diagram, Fig. 4, to which he refers was intended as a very much simplified graphical demonstration of the

manner in which pulses are emitted from a transmitter and then arrive at a receiver after reflection from an aircraft as target. It should, of course, have been explained, in the text or caption, that in actual operation the rate of emission of pulses must be slowed down so that, as Mr. Burtner states, there is only one pulse anywhere on the path transmitter-target-receiver at any instant. It is hoped that readers have not been led astray on this point, which is probably clarified by reference to Fig. 5 in the article under discussion. I submit, however, that Fig. 4 would look rather dull with only one pulse shown on the path A_1TA_2 !

Quality De-control

RECENTLY you published three articles on radio components and the "Services Radio Component Handbook." Since those articles appeared I have learned that behind the façade of that Handbook there is poverty and squalor. The high hopes which the component specifications had raised have been dashed by information which has reached me from the industry.

The fundamental principle behind all the specifications is that the articles should be tested to make sure that they conform, and continue to conform, to the specifications. To this end a complex sampling scheme was devised and incorporated in the plan for component specifications. Manufacturers welcomed the scheme when they were shown it, for it represented the simplest way of monitoring their products. Over two years ago the sampling system, which was a specially arranged form of Quality Control, was accepted by the manufacturers, and a handbook on its application was shown to them. That handbook is not yet issued, and in consequence the running tests on component production are not being carried out.

This is, sir, a most serious state

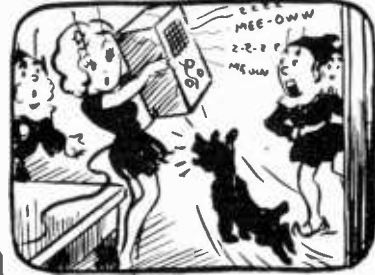

THE "FLUXITE QUINS" AT WORK

"Quick! Switch the set off," cried O.O.
"He'll wreck it! Then what shall we do?"
Said O.I. "Don't take fright,
What it needs is FLUXITE,
And that's a good cure for the Mew!"

See that FLUXITE is always by you — in the house — garage — workshop — wherever speedy soldering is needed. Used for over 30 years in Government works and by leading engineers and manufacturers. Of all Iron-mongers—in tins, 8d., 1/4 & 2/8.

Ask to see the FLUXITE POCKET BLOW LAMP. Price 2/6.

TO CYCLISTS! Your wheels will NOT keep round and true unless the spokes are tied with fine wire at the crossings AND SOLDERED. This makes a much stronger wheel. It's simple—with FLUXITE—but IMPORTANT.

The FLUXITE GUN puts FLUXITE where you want it by a simple pressure. Price 1/6, or filled, 2/6.



ALL MECHANICS WILL HAVE

FLUXITE

IT SIMPLIFIES ALL SOLDERING

Write for Book on the ART OF "SOFT" SOLDERING and for Leaflets on CASE-HARDENING STEEL and TEMPERING TOOLS with FLUXITE. Price 1d. each.

FLUXITE LTD.

(Dept. W.W.), Bermondsey Street, S.E.1

Letters to the Editor—

of affairs. There is still a war going on, for which radio equipment is needed: yet the organisation of component testing has been held up for two years. With the anarchy which production for home use will involve, it looks as though the work of the Committees has been wasted.

I can only recommend that equipment manufacturers should tear up the specifications, for they are meaningless, and that they should arrange for *Caveat Emptor* to be blazoned over the doorway which is now marked in their factories "Goods In."

THOMAS RODDAM.

Helping the Biologists

THE action potentials produced by living tissues such as muscle and nerve are very small—in some cases only a few microvolts—and accordingly very great amplification is needed to obtain a record of their activity either by an electromagnetic or by a cathode-ray oscillograph. The two chief difficulties are noise produced in the amplifier and interference picked up from the mains wiring or from apparatus connected to the mains. It is easy enough to screen a small piece of tissue, but it is very inconvenient to have to put a patient inside a screen. It may be very bad for obvious psychological reasons.

In these circumstances the article by Dr. D. H. Parnum on the "Phase-compressor" on page 19 of the January *Wireless World* is of interest to physiologists because it indicates one way in which the problem of interference might be solved.

I suggest that you would do a very useful service to biologists—many of whom have not had the advantage of a training in physics—if you could persuade Dr. Parnum to review known methods and to propose any improvements which would allow easier and more complete rejection of interference. It would also be valuable if any of your readers who have designed electrocardiographs or electroencephalographs would give us the benefit of their experiences. GEORGE H. BELL.

Institute of Physiology,
University of Glasgow.

Series "C" and Parallel "R"

DIRECT reading can be obtained on a slide rule, without reversing the slide, by transforming the formula:—

$$R = \frac{R_1 R_2}{R_1 + R_2}$$

into $\frac{R}{R_1} = \frac{R_2}{R_1 + R_2}$ or $\frac{R}{R_2} = \frac{R_1}{R_1 + R_2}$

using the figures quoted by "Diallist" in his graphical example:—

$$\begin{aligned} R_1 &= 20 \text{ k}\Omega \\ R_2 &= 30 \text{ k}\Omega \\ R_1 + R_2 &= 50 \text{ k}\Omega \end{aligned}$$

The slide-rule settings become:—

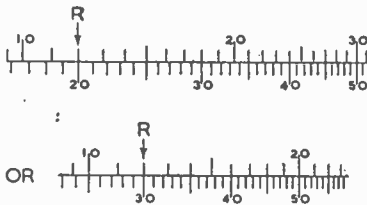

The process can, of course, be repeated for further resistors.

BASIL FORD.

Melsetter, Orkney Is.

Valve Colour Code

COLOUR coding of valves, in the manner suggested by K. E. Marcus in your June issue seems to serve no useful purpose. The knowledge that a defective valve has a certain heater rating is insufficient in itself to enable one to choose a replacement. The proposed code does not tell one whether the valve is a pentode or a pentagrid. Since it is not a practical proposition to put all the pertinent information in the form of colour coding, it will still be necessary to have recourse to a type number and a valve data book, so the *raison d'être* of the colour coding will disappear.

R. V. SHARMAN.

London, S.E.22.

In Defence of Electrolytics

WHILE agreeing with your correspondent S. Gould (April issue), that "midget" technique is the Serviceman's nightmare, it must be admitted that the midget set has come to stay, and that in UHF gear it is indispensable. Proper layout and wir-

ing, and due consideration for servicing, so rarely met with, would go far to ease the burden.

On the subject of electrolytic condensers, however, I fear your correspondent is a little out of date. Prior to the war, I would have agreed with him that a paper-type smoothing capacitor would be the most satisfactory. However, improvement on "dry" electrolytics has been so great under the demands of war that the position is quite different. For instance, the "Micro-pack" condensers mentioned in your RCMF Exhibition Review are the smallest *plain-foil* electrolytics ever produced (the practice of etching formerly used to increase the effective electrode area is unacceptable to the Services), and a 350V 8- μ F unit occupies only $2\frac{1}{2}$ in. by $\frac{1}{2}$ in. diameter. These components have had to be made both reliable and compact for use in ships, lifeboats, tanks, planes and in all the other arduous conditions of modern warfare. It is greatly to the credit of the manufacturers that they have succeeded. Improved electrolytics with higher permittivity under temperature of working, together with finer manufacturing techniques, will be largely responsible.

Many of the troubles associated with electrolytics arise from bad design or usage, and reflect on the fact that engineering safety factors are not properly applied (this is a particular failing of the amateur). The subject is worthy of wider reading, as in the well-known book by Coursey and an excellent paper by Cozens.¹ A pernicious practice which still persists is to rate the power-pack condensers by the working voltage *under load* and to allow no safety factor above this figure. This means that, if the power valve emission fails, little or no current is drawn, and the reservoir or smoothing condenser voltages rise to the peak supply voltage, which may be almost 50 per cent above the working voltage if the rectifier is heavily loaded. Desirable practice is to rate all such condensers at $\sqrt{2} \times$ HT supply volts, plus at least 20 per cent safety factor. This means using rather higher voltage condensers than normal practice. I have

¹ "Modern Condenser Technique," Cozens. *J. Brit. I.R.E.* Vol. 3, 1942-3, pp. 125-151.

found two types which are thoroughly satisfactory—922 TFX and MA14593, made by T.C.C. and B.E.C. (British Electrolytic Condenser Company, formerly Plessey) respectively. Both are 8- μ F condensers, rated at 600V and 750V respectively, although their performance is almost identical. They will safely withstand the full no-load voltage from a rectifier of the MU14 type operating from a 500/0/500 transformer; i.e., about 700V DC. These types are particularly useful for R-C amplifiers and other systems requiring a high "B" supply voltage.

Another design factor limits the load current allowable, as the periodic discharge and recharge due to this current causes a ripple voltage to appear across the dielectric which, if excessive, will cause breakdown by overheating.

In usage, I always make a practice of "forming" a new condenser by charging it slowly through a resistance of about 10,000 Ω from its working voltage. By doing this, the film, which tends to dissolve on standing, is built up to its proper value, and the resistance prevents excessive initial leakage current, which would overheat and destroy the film. Once the condenser is in

commission, the film tends to dissolve more rapidly, and it is highly desirable to activate every two or three months by simply switching on the supply. Thus sets which have stood idle for a long period need particular consideration, both for the good of the condensers and the rectifier! Wartime shortages accentuated this effect by the number of power-pack breakdowns which occurred when, after a long period, valve replacements again became available.

JOHN C. FINLAY.
East Boldon, Co. Durham.

Origins of PA

"FREE GRID'S" comments on PA equipment in the film "Wilson" match my own views. PA as we knew it in 1925 (or was it earlier?) was weird and wonderful; if there was any in 1916 it must have been primitive indeed.

S. G. Brown's direct-coupled valveless differential microphone system may have been available during the 1914-1918 war, and something like it may conceivably have been in use in U.S.A. at the same time. But would the film producers know—or care?

R. M. CLUCAS.
London, W.5.



The new Vortexion 50 watt amplifier is the result of over seven years' development with valves of the 6L6 type. Every part of the circuit has been carefully developed, with the result that 50 watts is obtained after the output transformer at approximately 4% total distortion. Some idea of the efficiency of the output valves can be obtained from the fact that they draw only 60 ma. per pair no load, and 160 ma. full load anode current. Separate rectifiers are employed for anode and screen and a Westinghouse for bias.

The response curve is straight from 200 to 15,000 cycles in the standard model. The low frequency response has been purposely reduced to save damage to the speakers with which it may be used, due to excessive movement of the speech coil.

A tone control is fitted, and the large eight section output transformer is available to match, 15-60-125-250 ohms. These output lines can be matched using all sections of windings, and will deliver the full response to the loud speakers with extremely low overall harmonic distortion.

PRICE (with 807, etc., type valves) £18.10.0

Plus 25% War Increase

MANY THOUSANDS ALREADY IN USE

VORTEXION LTD.
257, THE BROADWAY.
WIMBLEDON, S. W. 19.
Phone: LIBerly 2814



DIRECT-READING COMPASS

As was pointed out in the January *Wireless World*, recent improvements in aircraft direction-finding depend largely on the newly introduced Gyro-Magnetic (Direct-Reading) Compass. A repeater scale, showing true bearings, can be installed as part of the radio DF equipment, thus avoiding many of the time-wasting processes incidental to taking a bearing by older methods. This photograph, taken in the Ferranti works, where many thousands of the compasses have been made, shows an instrument undergoing tests.

RECENT INVENTIONS

SHORT-WAVE TUNING

CERTAIN parts of the short-wave tuning range on the ordinary broadcast receiver are much more crowded than others. In order to accommodate the tuning of the set to these conditions, the plates of the variable condenser are designed to give comparatively small increments of frequency change when passing through the congested areas. In addition, the space allotted to these areas on the indicator scale is relatively extended or magnified.

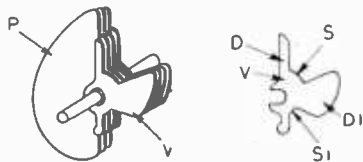

Bandspread tuning condenser.

As shown in the figure, the cut-away parts S and S1 of the rotary plates V, which produce only small capacity changes as they overlap the fixed plates P, are arranged to cover, say, the crowded 25- and 31-metre bands respectively, whilst the projecting parts D and D1 sweep quickly through the intervening "empty" bands. The same effect can be secured by using rotary plates of uniform size, and cutting out apertures of the required size and shape in the fixed plates.

A. F. Burgess (communicated by Zenith Radio Corpn.). Application date, May 21st, 1943. No. 565794.

FREQUENCY MODULATION

A DISCHARGE tube of the cathode-ray type, having one or more resonator units which serve to "bunch" or velocity-modulate the electron stream, is also utilised to generate a frequency-modulated signal.

Any known method of back-coupling can be used to generate a carrier wave of normally constant frequency. In addition, each resonator unit is fitted with a small coupling loop of wire, which is connected in series with an external impedance. Signals applied to this impedance vary its value and so control the instantaneous tuning of the resonator, thus producing a frequency-modulated signal at the output of the tube.

N. C. Barford. Application date May 5th, 1943. No. 565413.

TELEVISION "ECHOES"

OUT-OF-PHASE effects, similar to those of "fading," are produced in television by signals which arrive at the receiver after reflection from some high building or other obstacle in the neighbourhood, say, of the transmitter, so that they travel over a longer path than the direct signal. As the speed of the waves is roughly 1,000 feet per microsecond, a path difference of three miles will produce a time lag of 15 microseconds between the two sets

A Selection of the More Interesting Radio Developments

of waves. The reflected picture signals are usually too faint to be noticeable, but this does not apply to the echoes of the synchronising impulses, which are sufficiently strong to be seen out of place inside the picture frame.

To prevent or minimise this type of interference, a periodic change is imposed on the phasing of the transmitted carrier wave, and is timed so that successive echo signals cancel out in the receiver. For instance, the phase of the carrier is advanced by 90 deg. just before the transmission of a synchronising impulse, and is retarded by 90 deg. immediately after it. Both changes are made during the same blanking interval by raising or lowering the carrier frequency, say for a period of two microseconds in each case. The resulting phase change is sufficiently gradual to avoid the production of disturbing amplitude variations.

Philco Radio and Television Corpn. (assignees of D. B., Smith). Convention date (U.S.A.) May 5th, 1942. No. 566669.

AIRCRAFT INDICATOR DIALS

WHEN flying at night, the navigator should be able to scrutinise his instruments without having to meet "glare" or any ocular strain that might impair his normal ability to see in the dark.

For this reason the lamps for illuminating the indicator scales of a radio direction finder are mounted below the dial in a casing which is light-tight except for a centre viewing window. The fixed scale of the indicator lies directly under the window, whilst the outer movable scale carries a right-angle prism through which the light from the concealed lamps is reflected and diffused evenly over both the scales. The height of the prism is sufficient to prevent any direct leakage of light, whilst its base is blackened so as to appear dark from any outside line of sight.

Marconi's Wireless Telegraph Co., Ltd., and J. H. Moon. Application date March 24th, 1943. No. 566114.

RADIO NAVIGATION

THE relative bearings of several transmitters are shown simultaneously on the screen of a cathode-ray tube, together with their respective wavelengths.

As shown in diagram (a), the signals are picked up on a constantly rotating

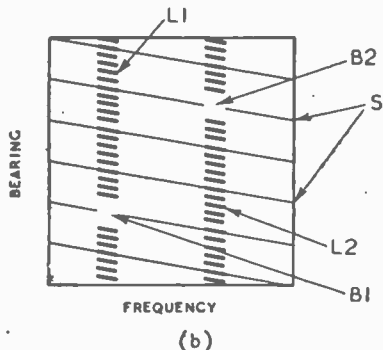
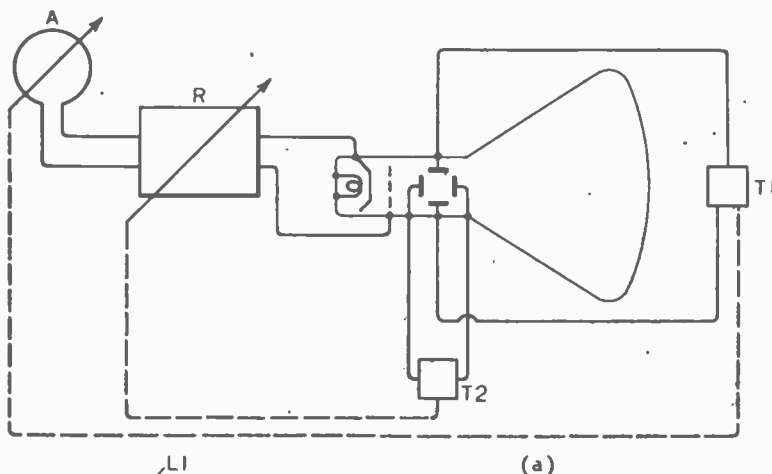

Direction finding system.

aerial A, the speed of which is synchronised with a time-base T1 feeding one of the pairs of deflecting plates of the tube. Simultaneously the tuning of the receiver R is constantly swept over a wide frequency band, say by a reactance valve, which is synchronised with a second time-base T2 working across the second pair of deflecting plates.

Assuming that signals from two different transmitters are reaching the control grid of the CR tube, the resulting picture is indicated in diagram (b), where the sloping lines represent one typical scanning sweep resulting from the two time-bases. As the tuning passes through the wavelength of each

transmitter, the trace is momentarily brightened to form the two vertical lines L₁, L₂, which serve to identify each station. Similarly when the rotating DF aerial passes through the "null" direction of each transmitter, the vertical lines are broken or "gapped" at the points B₁, B₂ to indicate their respective bearings.

H. Jefferson. Application date March 20th, 1942. No. 566026.

GANGING CONDENSERS

WHEN several circuits are to be ganged for simultaneous tuning it is necessary to provide some adjustable trimming device to offset the slight variations of manufacture and to allow the individual units to be accurately aligned after they have been assembled.

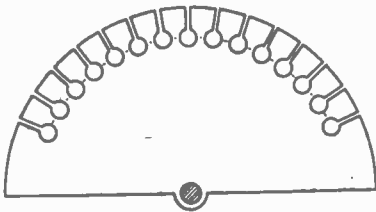

Detachable plate serrations.

For this purpose, as shown in the diagram, the periphery of at least one of the condenser plates is perforated or weakened in such a way that one or more of the scalloped parts can be broken off, as required. The perforations are sufficiently close set to allow the "tongue" between any two of them to be removed without straining the rest of the plate.

The Mullard Radio Valve Co., Ltd. and C. F. Maitland. Application date July 1st, 1943. No. 556703.

TUNING CONTROLS

THE selectivity of a receiver is automatically reduced by the operation of the volume control when receiving strong signals.

To secure this effect, the tuned input circuit is shunted by a diode valve, which is biased from a fixed point on a potentiometer so that it is normally non-conductive. The potentiometer is in the anode circuit of the next RF amplifier, and a variable tapping from it to the cathode of that valve provides the volume control. For signals up to a certain threshold strength, the diode is biased to cut-off. For stronger signals, as the volume control is moved to reduce the gain, the anode current through the second valve diminishes, and the bias on the diode will fall to the point at which it starts to pass current, and to operate as a high-resistance shunt on the tuning.

Marconi's Wireless Telegraph Co., Ltd. (assignees of A. D. Zappacosta). Convention date June 29th, 1942. No. 566540.

The British abstracts published here are prepared with the permission of the Controller of H.M. Stationery Office, from specifications obtainable at the Patent Office, 25, Southampton Buildings, London, W.C.2, price 1/- each.

It's the hidden details that count

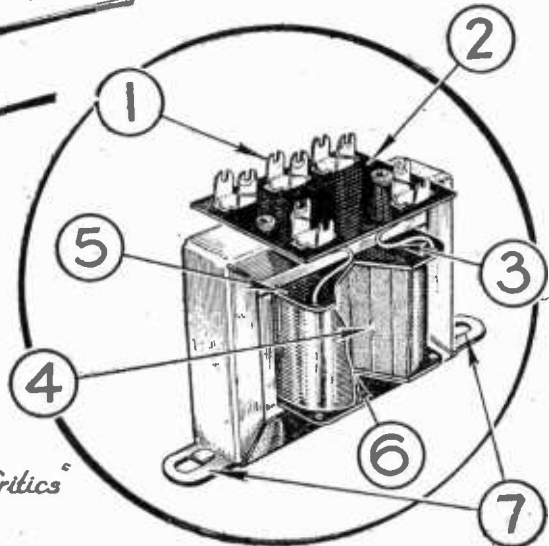

The choice of Critics

A.F. Voltage & Small-power transformers & Chokes for all types of electronic apparatus, in all normal ratings and in a diversity of physical sizes.

- 1 — Heavily silver-plated non-rotatable solder-tags for connexions.
- 2 — Tropic-grade synthetic-resin-bonded tag boards for high insulation resistance under all conditions.
- 3 — Colour-coded leads, welded to instrument wire in bobbin.
- 4 — Layered and sectionalised windings of highest-grade h.c. instrument wire.
- 5 — Synthetic-resin bobbin holding windings in immovable formation.
- 6 — Bobbin & Windings vacuum-impregnated and coated waterproof materials.
- 7 — Core shrouded and tightly clamped with maintained iron-circuit and fixing centres.



A. F. BULGIN & CO. LTD., BYE PASS RD., BARKING, ESSEX

RIPpleway 3474 (5 lines)

(The name "BULGIN" is registered Trade Mark)

UNBIASED

"Far from the Madding Crowd"

By

FREE GRID

I WAS interested to read in the June issue that, like myself, Diallist can be numbered among the wise virgins who realised that Sir Edward Appleton's recent radiolocation lecture at the I.E.E. was bound to be almost as much of a draw as a *cause célèbre* in the Divorce Court a little farther up the street. Like the wise man he is—I hardly like to continue the metaphor and call him a wise virgin—he got there early and managed to secure a seat.

Unfortunately, however, many of us upon whom the burden of the world's reorganisation and rehabilitation presses somewhat heavily cannot afford the necessary time to adopt this simple solution and have perforce to get there when we can. Actually when I *did* arrive, there was still plenty of standing room but this would have meant cutting out a buckshee tea, which, in these days of increased rationing stringency, I had no intention of doing.

Apart from this I am no fonder of standing than a Scotsman is and I had come scientifically prepared to hear the lecture in comfort, and I was truly astonished that so many who profess and call themselves electrical or radio engineers—members of the I.E.E. among them—had failed to do likewise. But after all, it is, I suppose, only what can be expected of people who, as I know for a fact, use gas fires and other relics of a bygone age in the sanctuary of their own homes.



An overflow meeting.

In order to hear the lecture in comfort I had provided myself with a really well-designed hearing-aid, details of which were given in this journal a few years back. The only departure I made from specification was to have a separate super-sensitive microphone attached to the amplifier by a long length of flex. It was a simple matter, of course, to get this passed along from hand

to hand and placed unsuspectingly in the speaker's office.

If the correct degree of bureaucratic bluster is used when handing the microphone to the first person in the chair, the thing is as good as done, as all the others who pass it along take it as being "official" and ask no questions. I have often thought, in fact, that by adopting this procedure it would not be difficult to get a small time-bomb along and am thinking of trying it out in the present election campaign.

I need hardly say that my ruse worked perfectly and I was able to enjoy the lecture from the comfort of a seat in an adjoining room. Naturally I attracted a certain amount of envious attention from several of the overflow who could not squeeze their way into the hall and I regretted that I had not brought several pairs of headphones. Eventually, however, I adopted the old trick we used to employ twenty years ago of putting the headphones in a pudding basin, so making a miniature loudspeaker around which several people crowded. My thanks are due to the anonymous member of the catering department who so kindly provided the basin; actually it was a large sugar bowl.

"Festina Lente"

NOW that the European war is a thing of the past, there are quite a lot of things which may be revealed which have been strictly *verboten* during the past six years and one of them is the extraordinary manner in which certain Government departments turned down various inventions and suggestions sent up to them, as being "of doubtful value." The monotonous regularity with which my own radio suggestions were returned, accompanied by this stock phrase, made me suspect that they were never examined.

As a test I sent up a suggestion quite early in the war that it would be in the national interests for television to be shut down and also that all amateur transmitting licences should be withdrawn, but as I had half expected, I was politely told that the idea had been carefully considered but that it had been found to be of "doubtful value."

No doubt the harassed Government department concerned were inundated with many absurd and even frivolous suggestions, and one must therefore make certain allowances for them, although it goes against the grain for me to do so. One of the most glaring instances of a valuable suggestion of mine being rejected was in connection with this double summer time business. As you know it has, year by year, aroused considerable opposition from certain sections of the community who pointed out, quite rightly, that cows, unlike publicans, were far from amenable to Government regulations in the matter of their opening and closing hours for liquid refreshment.



Cows are obstinate creatures.

I hold no brief for the farmer, but after all cows, like other members of the female species, are obstinate creatures and there is no reasoning with them. Like Hitler, their guiding light is intuition rather than cold reason.

There was one way, however, in which both cows and farmers could have been led to accept DBST without knowing that they had done so. In fact, as I told the Government, the whole country could have been induced to accept not only double but triple or even quadruple summer time if such a course had been thought necessary.

The method is simple and best summed up by the old Latin motto "*Festina Lente*." In spite of the fact that patches of DC still exist in this country a very large number of farms are served by the grid and use AC clocks. My idea was the simple but old one, which was, I believe, first suggested by Mr. Hope-Jones of horological fame for adoption on transatlantic liners. In brief, by a slight juggling with the frequency of the mains, AC clocks could be slowly moved on by one hour throughout the month of April, the reverse process being applied in the autumn. By arranging for the Greenwich time pips and Big Ben to fall into line the whole idea could have been made perfect and nobody would have noticed the deception.

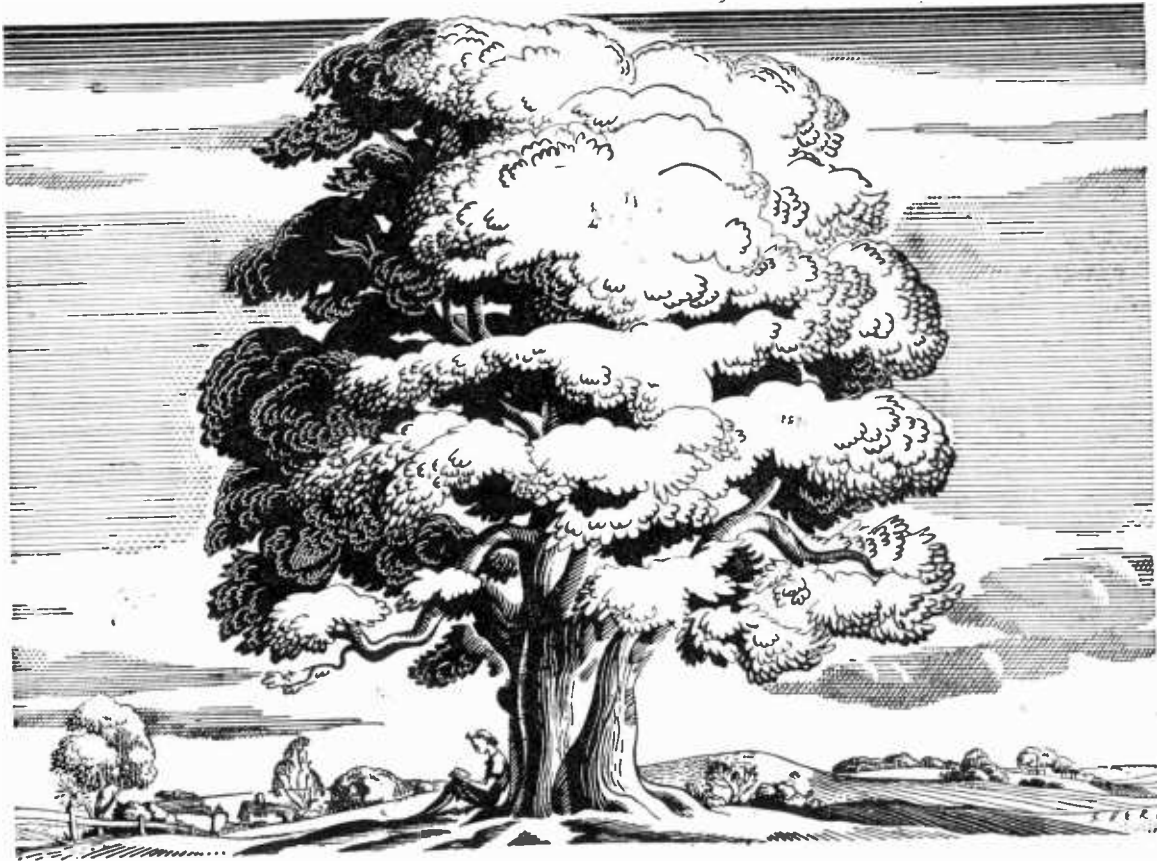

—and the roots go deep

Firm and enduring, the great tree stands, its roots spreading deeper and wider through the long years of steady growth.

So, too, have great industrial organisations like that of Philips grown and developed. The many Philips achievements and the high reputation of their products are rooted in persistent research, highly-qualified engineering

personnel, modern and efficient factories and long-accumulated knowledge and experience of the application of electricity to the needs of the modern world.

PHILIPS 
LAMPS ★ RADIO ★ X-RAY
COMMUNICATIONS EQUIPMENT
AND ALLIED ELECTRICAL APPLIANCES

PHILIPS LAMPS LIMITED, CENTURY HOUSE, SHAFTESBURY AVENUE, LONDON, W.C.2 (872)

Rate 6/- for 2 lines or less and 3/- for every additional line or part thereof, average lines 5-6 words. Box Numbers 2 words, plus 1/- Press Day: August 1945 issue, first post Tuesday July 10th. No responsibility accepted for errors.

NEW RECEIVERS AND AMPLIFIERS

COMMUNICATION receivers.—Remember "Dale" after the war.—Dale Electronics, Ltd., 152-6, Gt. Portland St., W.1. Mus. 1023.

COMMUNICATION receivers.—As soon as civilian supplies recommence we shall be at your service.—A.C.S. Radio, 44, Widmore Rd., Bromley, Kent. [3805]

HENRY'S offer 4-valve a.c./d.c. Midget kit sets, complete with all components, drilled chassis and circuit, excellent results, nothing else to buy, £4/10; valves, £2/10; speaker, £1/9.

HENRY'S, 5, Harrow Rd., Edgware Rd., Paddington, W.2. Tel. Pad. 2194. [3932]

QUALITY amplifiers, 200-250v ac, 5 watt 8½gms., 12 watt £14; s.a.s. for fully illustrated leaflet and copy of "Design for Quality"; immediate deliveries.—J. H. Briery (Gramophones and Recordings), Ltd., 403, Mill St., Liverpool, 8, Lark Lane 1709. [3796]

HIGH quality receivers of exceptional performance now being prototyped; two models will be available; deliveries to begin December; limited supplies only; also multi-range a.c./d.c. meter and 1.5-300-volt valve-voltmeter (a.c./d.c.); enq. invited.—Box 3480, O. [3928]

BAKER'S—New 7-valve "Wireless World" quality amplifier with tone control stage, 8 watts push-pull triode output, price includes super quality triple cone, 12in permanent magnet speaker, with large output transformer and all valves; also as above but with 15 watts tetrode output, ideal for realistic reproduction for public address; limited orders only. 2½d. stamp for particulars, prices, etc.—Bakers Selhurst Radio, Tel. Croydon 4226.

RECEIVERS, AMPLIFIERS—SECOND-HAND HALLICRAFTER Super Defiant SX25, with loud-speaker; offers.—Box 3471.

HALLICRAFTERS SX28, complete with 12in R.K. speaker.—Offers to Box 3477.

HALLICRAFTERS, special SX17, unblemished, with matched speaker; £50, or offer.—Box 3484. [3928]

HALLICRAFTER'S SX24 communication receiver, with speaker and spare set of valves; £45.—Box 3468. [3863]

RADIO sets, amplifiers and radio sundries; list free; state needs.—A.C.S. Radio, 44, Widmore Rd., Bromley, Kent. [3806]

ARMSTRONG AW125PP, 12v 5-band, 12-550 continuous, 1,000-2,000m., 14in cner. speaker.—Bird, 111, Cecil Rd., Norwich.

QUALITY receiver, push-pull PX4's, resistance coupled, with straight tuner unit (2RF stages) and separately energised 10in speaker; £25, or best offer.

D.C. Quality amplifier and tuner unit (1HF stage and det.), 110 to 250 volts operation; £18, or best offer.

PHILIPS car radio for 12 volts, in working order; offers.—Barton, Oxlynch, Stonehouse, Glos. [3877]

W.W. Small Quality receiver, B.T.H., L/S, in very beautiful Console cabinet by Maples, Ltd., 26gms; M/C meter, 0-100 m.a.s. £2/10.—16, Jennings Rd., St. Albans. [3872]

HAYNES radiogram, including 2 PX25 valves; can be viewed by appointment, Mondays and Sats. excepted.—Mrs. Christmas, 73, St. George's Drive, Victoria, S.W.1. [3913]

NATIONAL H.R.O., complete 4 coils and power pack, as new, one owner, regularly serviced; price £80.—Noton, 15, Rutland Rd., Southport. (Tech. partics. from Service Engineer Marsh, 19, Carlisle Rd., Birkdale, Southport.) [3935]

PROBABLY finest English receiver ever made: 1940 luxury HMV auto-radiogram and television type 900, in superb walnut cabinet, hardly ever used owing evacuation, as new throughout; price for immediate sale, 200gms.—Harris and Gillow, 93-5, Wardour St., W.1.

THE output stage of a 500-watt amplifier, comprising a pair of Standard telephones, 212D valves (250 watts, £30 each. list), with Giant Jumbo holders, filament transformer, high-tension transformer, mercury vapour rectifier, Ediswan type E.S.U. with holder pair of output chokes, h.t. choke and pair of smoothing condensers price £35.—Heather-side, Hurst Drive, Walton-on-the-Hill, Surrey. [3879]

SALE 12-watt Class A push-pull negative feedback amplifier in 7-gn. grey and chromium cabinet, separate M.V. radio unit, 50-watt Multiratio output transformer, £15 complete; new Mallory vibrator pack, 6-volt to 180-volt, 35m.a., £3; almost new Exide car battery, 6-volt, 100 a.h., £3; moving coil microphone in cracked desk cabinet, Mumetal input transformer, £2/10; many other bargains; write requirements.—Box 3466. [3855]

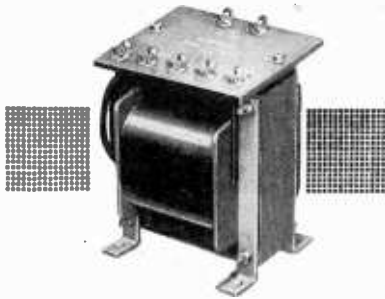

For the past 15 years we have devoted our energies exclusively to the manufacture of Transformers and Chokes. Although we continue to be very active in the field of Research and Development, we are nevertheless giving much of our attention to increasing our range of mounting facilities.

Illustrated above is one of the varied range of styles shown in our Catalogue which is now in preparation. If you would like a copy, please write to us (enclosing 1d. stamp) and we will send you one immediately it is ready.

Telephone:



Abbey 2244

PARTRIDGE TRANSFORMERS LTD

6-8, PETTY FRANCE LONDON S W

'SELECTEST'
is
Coming
... will interest
every Electrical
and
Radio Engineer.

SALFORD ELECTRICAL INSTRUMENTS LTD.
PEEL WORKS SALFORD 3

NEW LOUDSPEAKERS

NEW Broadcast P.M. loud-speakers, 3 models; 12in 12watt 15,500 lines, 1½ dia, voice coil; 12in 25watt 18,000 lines, 1½ dia, voice coil; 15in 40watt 18,000 lines, 2½ dia, voice coil; machined and precision built instruments, Ticonal magnets, detachable diaphragms, die-cast chassis, uniform response, accuracy, tonal quality, appearance and finish; superior standards in fidelity, sensitivity, prompt deliveries; specifications and illus. upon request.—Broadcast & Acoustic Eq. Co., Ltd., Broadcast House, Tombland, Norwich, (2537) £5/18/6.—New Baker Super Quality 2in

£5 Auditorium permanent magnet speaker with triple cone, manufactured by Bakers Selhurst Radio, the pioneer manufacturers of moving coil speakers since 1925, wide frequency range, even response, ideal for quality reproduction, fitted with magnet, having exceptionally high flux density in the air-gap, suitable for public address equipment when quality reproduction is first consideration; send 2½d. stamp for leaflet giving details of above and constructional details of a new acoustic chamber designed to extend loud speaker frequency range; also constructional details of an infinite baffle cabinet; every music lover interested in realistic reproduction should write for leaflet.

£8/19/6.—New Baker super power cinema permanent magnet speaker with 18in triple cone of new design, giving wide frequency response free from objectionable resonances; speech is clear and natural and music is reproduced with exceptional realism; fine engineering job, extremely sensitive, ideal for public address equipment when power handling capacity, plus realistic reproduction, is required; present deliveries of speakers three to four weeks.—Bakers Selhurst Radio, 75, Sussex Rd., S. Croydon. Tel. Croydon 6813.

LOUDSPEAKERS, SECOND-HAND 2-TRIX P.A. horn speakers, 15 ohms, 15 watt.—Barton, Oxlynch, Stonehouse, Glos. **MAGNAVOX** moving coil speaker in case, Marconi eliminator, 250 volts.—Scammells, Fashion St., E.1. Bishopsgate 3521. **R.K.** 12in P.M. massive Jensen, energised, £25 ea.; 1932 Monodial, less valves, £8; O.P.M.I. 10/-, A.F.3 7/-, 8.V.4 mains trans. £1, H.T.8 7/-, Colvern 110 I.F.S. 10/- pair; s.a.c.—Box 3474. [3882]

DYNAMOS, MOTORS, ETC. H. offers following clearance items at bargain prices, subject to sale.

ROTARY converters: 500 watt Mackie, 100v dc to 110v ac, £12/10; 900 watt Lang and Squire, 230v dc to 230v ac, £20; 60 watts Lang and Squire 24v dc to 230v ac, £8/10; electron inverter, 300 watts 110v dc to 110v ac, £7/10; Crompton, 1,500 watts, 230v dc to 110v ac, £22/10.

A.C. MOTORS, all 230v 1 phase 50 cycles, 1/6hp B.T.H., £3/10; ¼hp Hopkinson, £5/10; 1hp Brook, £9; 3hp Higgs, £14; 4hp Brook, £17; 5hp Brook, £20; 10hp Brook, £25.

FULL lists sent on receipt of stamp.—H. Harris, Strouds, Bradford, Berks. Tel. Yatterley 254 (London Toll Exchange). [3890]

NEW ac motors, ¼hp, high starting torque, 200-250v, £4/15; ¼hp, £5/5; ¼hp, £7/5; 1hp, £9/7/6; all other sizes available; also machinery.—John W. W. Steel, Bingley, Yorks.

ROTARY converters.—12-volt d.c. input, 300 volts 100 m.a. d.c. output, on ball bearings, £3/10; another, by Westinghouse, input 24 to 28 volts d.c., output 350 volts 120 m.a. d.c., ball bearings, £3.—Barton, Oxlynch, Stonehouse, Glos. [3879]

ELECTRADIX dynamos, 1½ and 1½ G.E.C. double current, 6r and 600r, weight 17lb, 37/6. pkg. and carr. paid; supplied Eng. and Wales only; refund 5/- on returned cases; dc motors, 1-5hp and ¼hp dc motors, enclosed, silent, 220 to 250v, 1,500 revs, double-end ¼in shaft, first grade make, guaranteed, 1-5hp, £3/10 each; ¼hp £4 each; all carr. paid Eng. and Wales; others in stock.—Electradix, 214, Queenstown Rd., Battersea, London.

ALL types of rotary converters, electric generators, battery chargers, petrol-electric generator sets, etc., in stock, new and second-hand; supplied against priority orders only.—WARD, 37, White Post Lane, Hackney Wick, E.9. Tel. Amherst 1393. [1988]

NEW MAINS EQUIPMENT VERTEXION mains transformers, chokes, etc., are supplied to G.P.O., B.B.C. L.P.T.B.; why not you? Imitated but unequalled; orders can only be accepted against Government contracts.

VERTEXION, Ltd., 257, The Broadway, Wimbledon, London, S.W.19. Lib. 281.

TEST EQUIPMENT HUNT'S resistance capacitor analyser wanted, good working order essential.—A. Marks, 102, Cromwell Rd., Peterborough.

PREMIER RADIO

SOUTHERN RADIO'S wireless bargains:—

LATEST radio publications.—"Radio Valve Manual," equivalent and alternative American and British types with all data, 3/6; "Radio Circuits," fully illustrated receivers, power packs, etc., 2/-; "Amplifiers," fully descriptive circuits, 2/-; "Radio Pocket Book," Formulas, tables, colour code, etc., 1/-; "Radio Coil and Transformer Manual," 2/-; "Test Gear Construction Manual," 1/6; "Short Wave Handbook," 2/-; "Manual of Direct Disc Home Recording," 2/-; "10-How for Radio Constructors," 1/-.

POST Office paper conds., 2mf, upright, used but guaranteed perfect, 2/6; Mainbridge conds., 2mf, 3/6; 1mf, 3/-; 2.5+2.5-1 (6mf), 7/6. ACE P.O. microphones, complete, ready for use, with trans, 7/6; permanent crystal det., 2/6; crystal & catwhisker, 9d; insul. push-back wire, 25yds 5/-; insul. sleeving, ascd. colours, 3/6 doz yd lths; single screened wire, 10/- doz yds; twin screened wire, 17/- doz yds; power rheostats, 10 ohms 4/6, 30 ohms 4/6; push button switches, 3-way 4/-, 8-way 6/- (with knobs); escutchcons for 8-way p.b. switches, 1/6; pointer knobs, black, brown, special instrument types, 1/4in fitting, 1/- ea.; round black or brown knobs, 1/4in, 1/- ea.; resistances, brand new wire ends, 1/4, 1/2, 1 & 2 w. mostly low values, 30/- per 100 res.; heavy duty I.L. chokes, 30 hys, 250ohms, 100ma, 14/-; 500ohms, 16/-; 1,000ohms, 17/6; Yaxley type rotary switches, 11-way single bank, 6/6, brand new; soldering tags, incl. spade ends, 1/6 gross; Multicon mica conds., 28 capacities in one, 0.0001 upwards, 4/-; mounting valve holders, English & American types, 1/- ea.; trimmers, 30pt, 1/- ea.; hundreds more bargains.

SOUTHERN RADIO SUPPLY Co., 46, Lisle St., London, W.C. Gerrard 8653. [3785]

CHARLES BRITAIN RADIO (K. H. EDEN)

—Special clearance bargains.

SERVICE kits.—One 15mf 450v can, one 8mf 450v tubular, three 2mf 25v cans; £1. SHORT wave tuning condensers, 0.00015, precision job on ceramic base, with long spindle, 5/- ea.; volume controls, Morganitem short spindle, 50,000 ohms, 1/3 ea.; tubular condensers, 1,000v test, 600w kg., 0.05, 3/6 doz; Cussor knobs, less grub screws, 2/6 doz; small brown knobs with grub screws, 4/6 doz; sleeving, 1mm, various colours, 1/6 doz yds. OSCILLATOR coils and two I.L. trans., 1/6 k/c, exc Ekco, 5/- per set; Marconi vertical glass dials, three band, 1/- ea.; Yaxley switches, 3-pole 4-way, 2/9 ea.; all regular lines still available; send 1d. for price list; terms, cash or c.o.d. over £1.—Charles Britain Radio (temp. address), "Eureka," Surrey Gdns, Effingham, Surrey (not Egham, as incorrectly printed in June issue). [3918]

PARK RADIO SERVICE, 27, Upper St., London, N.1. Tel. Canonbury 1384.

LOUDSPEAKERS, all with output transformers; special offers, 6 1/2in p.m., 22/6; 10in m.e., 1.100 ohms field, exponential cone, 45/-; Celestion, 8in p.m., 27/6, 10in p.m., 45/-; R. and A. 6 1/2in m.e., 1.100 ohms field, 30/-; Goodman 3 1/2in p.m., less trans., 3.2 ohms, 30/-.

LINECORD, special offer, 60-70 ohms per foot, 2-way 10d. ft., 3-way 1/3 ft.; second quality, 3-way, 1/- ft.

COILS, Midget m.w. aerial & h.f., 6/6 per pr. CONDENSERS, small 2-gang, with trimmers and brackets, 15/6.

OUTPUT transformers, multi ratio, with centre tap, 8/6.

VOLUME controls, long spindles, all usual values; less switch 3/6, with switch 5/6.

VALVES.—No permits now required; most types in stock, DA30, PX25, PX4, PENB4, KT33C, URIC, UA20, PEND14020, TH30C, 3Q5, IN5, IC5, IH5, etc. (Sorry no 0.15 amp series at present.)

ENQUIRIES invited for items not listed; terms cash with order or c.o.d. over £1; please add cost of postage and packing.

PARK RADIO SERVICE, 27, Upper St., London, N.1. [3901]

STRONG steel chassis, 6x9x2 1/2, drilled four holes, 1.0. sockets, three control holes, fixing feet, anti-rust finish; 8/- each, post paid; s.a.e. for quotation other sizes.—Noller, Aldeburgh, Suffolk. [3911]

Be sure and write now for our gigantic new mail order list "W.W." Hundreds of bargains and short supply lines available at once from stock; list W.W., 2/6d. post paid.—Waveband Radio, 63, Jermyn St., S.W.1.

SERVICEMEN.—The following products are well designed and of high quality; volume controls, carbon type, a valve, with or less switch, wire-wound resistors, 1 to 60 watts; droppe, wire-wound resistors, 1 to 60 watts; razor resistors; terms and quotations on req.—Dagole, Ltd., 35, High St., Quislip, Mdx.

UNI Taylormeter 90, £15; incomplete valve-tester, £4; other items.—Box 3465.

PORTABLE oscillograph in standard metal cabinet, hard valve time base; £25-37.

Weardale Ltd., Sherwood, Nottingham. [3931]

OSCILLATORS, signal generators, multi range test meters, etc., test gear of every description, British or American, required, serviced, re-lubricated.—A. Hucksell, "Hazel," 107, Crofton Lane, Orpington, Kent. [3031]

HIGH quality amplifiers and electronic test gear built to customers' requirements; capacity now becoming available for low priority work and limited commercial productions; please send full details of your requirements; we will quote you by return.—Banks (London), Ltd., 111, Clapham High St., S.W.4.

UNUSED Avo mains oscillator, all wave, 14gns.; Newtons 3-circuit battery charger, with spare valve, £13; Neobeam oscilloscope, 17gns; quantity 37 s.w.g. enamelled copper wire, 3/6 lb.; T.C.C. 1,000mf, 12-volt electrolytics, 7/6 each; full wave metal rectifiers, 12volt 10amp, 35/-; 12volt 6amp, 28/6; 12volt 3amp, 22/-; 12volt 2amp, 20/-, brand new; F.M.I. cabinet polishing kit, unused, £4.—Box 3483. [3297]

GRAMOPHONE AND SOUND EQUIPMENT H.M.V. Hyper, latest 20hm model, special trans.—Offers Box 3469. [3864]

COIL P.U. and equaliser, miniature needle.—3, Balmoral Rd., Aberdeen. [3865]

GARRARD ac motor and pick-up on motor board.—Offers, 64, Park Av., Orpington.

A.C.D.C. Garrard record changer, good cond.; £14.—Meakin, Drakes Bridge, Eckington, Wores. [3873]

CRYSTAL pick-ups, with arm, screened lead and stand; only at £3/2/6.—David Robinson, Ltd., 100, High St., Bedford. [3861]

LOOK out for valves and circuit analyzer; details later.—London Sound Labs., Ltd., 40, South Molton Lane, Bond St., London, W.1.

LI, B.V.A. valves available, also number of discontinued types; list prices; pro forms or c.o.d.—David Robinson, Ltd., 100, High St., Bedford. [3421]

HARTLEY fans, brand new 6J5's, by Standard Telephones, 7/6 each, 3 for 21/-, 6 for £2; cash with order, carriage paid.—Seymour, 36, Melthorne Drive, S. Ruislip, Mdx.

OUR adaptors will help in replacing unobtainable valves; send 7d. for interesting booklet on valve replacements; trade enq. invited.—V.E.S., Radio House, Ruislip.

COMPONENTS—SECOND-HAND, SURPLUS VALUE! Matt has it!

LINE CORD.—2-way 2/6 per yd., 3-way 3/- per yd. (approx. 60ohms per foot).

SPEAKERS.—Celestion P.M. 2 1/2in, less trans., 27/-; 8in P.M. with trans., 27/6; 6 1/2in P.M. (multi-ratio trans.), 28/6; Rola 6 1/2in P.M. with trans., 28/6.

TWO gang condensers, 0.0005 with trimmers, 12/6; Midget coils h.f. and aerial, 5/- per pair.

VOLUME controls (all values), 1-switch 3/6, w/switch 4/6, mains transformers 4v and 8v, 27/6; Rothermel (crystal) pick-ups, met. S. £3/3/6; Sennelby, £3/18/9; condensers, all types in stock, 2s, 8s, 16s, 20/20, 500v working; 0.1, 0.01, 0.25, 0.05, 25x25, etc. Resistances, 1/2 and 1 watt; all values 1/- each, 10/6 per doz.

LET us quote you for all your requirements. Cash with order, plus postage.

MATT RADIO SERVICE, 152, Richmond Rd., Kingston-on-Thames, Surrey. [3758]

LOOK out for valves and circuit analyzer; L details later.—London Sound Labs., Ltd., 40, South Molton Lane, Bond St., London, W.1.

DUPLICATE, new, 1,000-volt wkg. oil-filled condensers, 8mf, 34/-; 4mf, 16/6; add 1/- for postage and packing.—To Radio Services, 4, Florist St., Stockport. [3875]

NEW acorns, 954, 956, 50/-; 955, 45/-; electric irons, 230-250v, with flex 27/6 excel. del.; headphones, good quality, 22/6; plastic wood, large jar, 3/- post free; knobs, bakelite, brown, 9d.

J. BULL & SONS (Folio W.W.). 246, High St., Harlesden, N.W.10. See our display ad on page 31. [3897]

RADIO and electrical engineers.—Ex-Govt. side cutters, 28 1/2 doz.; long-nosed insulated pliers, 22/6 1/2 doz., 42/- doz. prs., carriage paid, guaranteed brand new, mains transformers, 4v or 8v, heaters, 80ma, 28/6; 120 ma, 37/6; multi output transformers, standard size, 6/6; carriage paid orders £5; s.a.e. for list radio types.—A.D.S. Co., 261-5, Lichfield Rd., Aston, Birmingham. 6. [3299]

BARGAINS.—Ex-Govt. surplus: mains transformers, 2,500v, 4v, 1.5a, 2v, 2a, 35/- ea.; meters: electrostatic, 0-1,500v, 80/- ea.; 500-0-500 micramps, suitable for galvo, 60/- ea.; Yaxley switches, 3-way, 5-bank, 7/6 ea.; resistors, 50 assorted, 1/4, 1/2, 1 watt, carbon, wire ends, 10/6; large asst. service components in stock; s.a.e. for list.—Heathcote, 24, Durnford Ave., Urmoston, Lancs. [3871]

ALL POST ORDERS TO: JUBILEE WORKS, 167, LOWER CLAPTON ROAD, LONDON, E.8. (Amherst 4793.)

CALLERS TO: JUBILEE WORKS or 109, FLEET STREET, E.C.4. (Central 2833.)

Send for details of other accessories available. All enquiries must be accompanied by a 2d. stamp.

ELECTRIC CLOTHES PRESSING IRONS, 5 lb., pre-war quality, with lead, 33/6.

METERS. First grade army type Universal Test Meters in shockproof bakelite cases, ranges 10, 100, 500 volts at 1,000 ohms per volt A/O and D/O, 1, 10, 100, 500 m/a DC, 0-1,000 ohms, £8 15s.

FIRST GRADE METERS. 3 1/2in diameter, 1 milliamp, £2 12s. 500 microamps, £2 12s. 6d. 4 1/2in. 1 milliamp, £3 5s.; 500 microamps, £3 11s. 6d. Westinghouse Meter Rectifier for either type, 10/-; Multiple shunts 10, 100, 500 m/a, 10/-; Any value multiplier, 2/6 each. SUPER QUALITY AMPLIFIERS, 12 watts output, high and low gain inputs with mixer, treble and bass controls, two DB 350, 500 cycles, negative feedback, 2, 4, 8 and 15 ohms output, £14 14s. AC/DC AMPLIFIERS, 5 watts output, high gain, three-stage, feedback, £8 8s.

BATTERY CHARGERS for 2v. batt. at 1a, 25/-; for 2, 4 or 6v. batt. at 1a, 45/-; for 6v. batt. at 1a, 30/-; for 2, 6 or 12v. batt. at 1a, 49/6; for 6v. batt. at 4a, 23 10s.; 12 v. 4 amps., £4 10s.

MAINS TRANSFORMERS, 300+300 v., 60 m/a, three 4 v. 2-3 a. windings, 25/-; 350+350 100 m/a, 5 v. 2 a., 6.3 v. 2 a., 29/-; 350+350 100 m/a, three 4 v. 2-3 a. windings, 29/-; 350+350 150 m/a, two 4 v. 2-3 a., two 4 v. 1 a. windings, 39/-; 350+350 150 m/a, 5 v. 2 a., 6.3 v. 2 a., 6.3 v. 2 a., 38/-; 500+500 250 m/a, 5 v. 3 a., 6.3 v. 2 a., 6.3 v. 4 a., 65/-; 425+425 200 m/a, 4 v. 2-3 a., 4 v. 2-3 a., 4 v. 2-3 a., 47/-; 350+350 150 m/a, 4 v. 1-2 a., 4 v. 2-3 a., 4 v. 3-4 a., 38/-; 500+500 150 m/a, four 4 v. 2-3 a. 1T windings, 47/-.

1-VALVE BATTERY S.W. RECEIVER, with 2-volt valve, 4 coils, 12-170 m. bandspread tuning, 55/-, including tax.

STEEL CHASSIS, 10x8x2 1/2in., 7/-; 16x8in., 8/6; 20x8in., 10/6; 12x9x2 1/2in., 7/9.

SHORT-WAVE COILS, incl. octal sockets, 4-pin aerial coils, 9-16, 12-26, 41-94, or 76-170 m., 2/6 each; 150-350 or 255-550 m., 3/-; 490-1000 or 1000-2000 m., 4/-; 6-pin H.F. Trans., 9-18 12-26, 22-47, 41-94 or 76-170 m., 2/6. 8-W. chokes, 10-100 m., 1/3; 5-200 m., 2/6.

SHORT-WAVE CONDENSERS, easily ganged, 15 mmf, £1 1s. 25 mmf, 3/3, 40 mmf, 3/3, 100 mmf, 5/11, 150 mmf, 4/8, 250 mmf, 6/8; shaft coupler, 7/4; flexible ditto, 1/6. Dual bandspread for use with 2-gang, 6/6.

MIDGET "P" TYPE COILS, 19-35, 16-47, 34-100, 91-261, 250-750, 700-2000, 200-557, available as H.P. trans., aerial, or osc. coils, 2/3 each. Yaxley type wave-change switches, every type available; locators, 2/- each; wafers, 1/- each. Small 2-gang condensers: 0.0005, 15/-; matched pairs non-cored 465 K.O. I.F. trans., 15/- pair; midget type, 21/- pair. 60 mfm. trimmers, 1/-; osc. padder, 750 mfm., 1/9; B.F.O. coil 2/3.

CONDENSERS, 25 mf. 25 v., 2/3; 50 mf. 50 v., 3/6; 16+8 500 v., 10/6; 16 mf. 150 v., 5/-; 16 mf. 350 v., 4/-; 4 mf. 450 v., 7/6; 2 mf. 350 v., 3/9; 50 mf. 12 v., 2/3. Repairer's kit, 20 our assortment resistors and condensers, 38 mf. 450 v. electrolytics, six octal sockets, 13 yds. pushback, 35/- the lot.

CRYSTAL PICKUPS. Cosmocond, £3 11s. Rothermel super, £3 18s. 9d.

AMERICAN VALVES, 4525, 3525, 2525, 128K7, 128J7, 2525, 6V6, 6F6, 6Z4, 80, 6L7, 6K7, 1N6, 100, 1H5, 1T5. Many others available.

SUPER GIANT FULL-PULL INTER-VALVE TRANSFORMERS, 21 1/2 in. midget type, 12/6.

MIDGET ALL-WAVE RADIOS, AC/DC. We can supply circuit and all parts for sale. Write for details.

MOVING COIL SPEAKERS. Rola 6 1/2in. or 8in. F.M., no trans., 25/-; Plessey 8-in. P.M. with trans., 29/6. Goodmans 3 1/2in. P.M. with 3 or 15 ohm voice coil, no trans., 30/-; 8in. 100 ohm energised speakers, 35/-; midget standard or P.P. trans. for any above, 10/6. Super quality giant Matchmaker output transformers, match any tube single or P.P. to any voice coil, 7-watt, 22/6; 15-watt, 30/-; 30-watt, 49/6; 60-watt, 59/6.

CHOKES H.F. 300 ohms, 40 m/a, 4/6; 30H, 400 ohms, 60 m/a, 13/-; 30H, 100 m/a, 400 ohms, 19/6; 30H, 185 ohms, 150 m/a, 25/-; 25H, 250 m/a, 120 ohms, 39/6.

SUNDRIES. 2 mm. Systoflex, 2 1/4 yd.; resistor-cored solder, 6d. per oz or 4/6 per lb.; screened 2-pin plugs and socket, 8d.; ditto, 8-pin, 2/-; Octal socket, 10/4; ditto, ampheet type, 1/3. Valve screens, 1/2; 4 v. vibrator, 4-pin, 12/6. 50ft. Indoor Aerial, 2/6.

Now available for
LOW VOLTAGES
12v. and 24v.

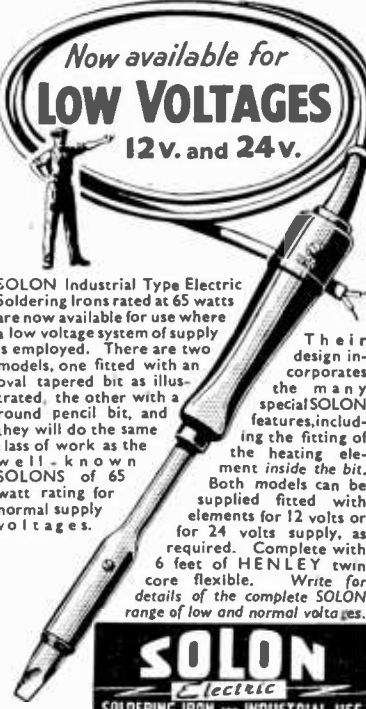

SOLON Industrial Type Electric Soldering Irons rated at 65 watts are now available for use where a low voltage system of supply is employed. There are two models, one fitted with an oval tapered bit as illustrated, the other with a round pencil bit, and they will do the same class of work as the well-known SOLONS of 65 watt rating for normal supply voltages.

Their design incorporates the many special SOLON features, including the fitting of the heating element inside the bit. Both models can be supplied fitted with elements for 12 volts or for 24 volts supply, as required. Complete with 6 feet of HENLEY twin core flexible. Write for details of the complete SOLON range of low and normal voltages.

SOLON
Electric
SOLDERING IRON FOR INDUSTRIAL USE

W. T. HENLEY'S TELEGRAPH WORKS
COMPANY, LIMITED,
Engineering Dept., Milton Court,
WESTCOTE • DORKING • SURREY

HILL & CHURCHILL

BOOKSELLERS

SWANAGE DORSET

ENGLISH & AMERICAN
BOOKS IN STOCK ON
RADIO AND
TELECOMMUNICATION

CATALOGUE ON APPLICATION

"ENGINEERING OPPORTUNITIES"



This unique handbook shows the easy way to secure A.M.I.Mech.E., A.M.Brit.I.R.E., A.M.I.E.E., City and Guilds, etc.

**WE GUARANTEE—
"NO PASS—NO FEE."**

Details are given of over 150 Diploma Courses in all branches of Civil, Mech., Elec., Motor, Aero., Radio, Television and Production Engineering, Tracing, Building, Govt. Employment, R.A.F. Maths., Matriculation, etc.

Think of the future and send for your copy at once—FREE.

B.I.E.T., 387, SHAKESPEARE HOUSE,
17, STRATFORD PLACE, LONDON, W.1.

G. A. RYALL, 36, Huron Rd., London, G.S.W.17. Mail order only, no c.o.d. under £1 please.

INPUT strips, 2in x 3/4in, with terminal screws, 2-way, 2/6 doz; anchor or mounting strips, 5-way, spaced for half and 1 watt resistances, 2/6 doz; octal 8-pin plugs, with insulated metal cap, complete with international octal chassis type base, 1/3 ea, 3 for 2/6; ditto, with solder tags, to take heavy gauge wire, 1/4 ea, 3 for 3/-.

MINIATURE 4-pin plugs, robust pins, with metal caps, complete with socket, 3 for 1/6, per doz 4/9; valve holders, chassis type, our regular line in these available once again, 5- and 7-pin British 4, 5 and 6-pin UX American, international octal (for 6V6, etc.), all 4/6 per doz, or per 100 29/6.

DIAL plates, oblong, 5 1/2 x 2 1/2, Varley, 200-550, etc, transparent, 4 1/6; Burndept 4-band dial 8 x 5 1/2, a.w. on lower half of scale, 1/6 ea.

SPECIAL offer T.C.C. mica conds., double 0.0001 x 0.001, 5 (10 condensers) for 1/3; Hunts' 0.01 mica, 1/- ea; Vaco type low loss switches, single-pole, double-throw, 2-bank, 2/9; single bank 2/3.

TEN-WAY cable, with five 5amp conductors for low tension current, 3 yards 4/9; push-back connecting wire, stranded, 2 colours, cotton covered, 12yds 2/3; twin rubber flexible, one cover, for mains leads, etc., 3yds 2/9; Morganite long spindle vol. controls, 10,000ohms, less switch, 3/9; Centralab 1/2meg vol., less switch, 3/9.

ERIE colour coded resistances, 2w, 680, 6,800, 140,000, 150,000, 220,000, 470,000, 820,000, 2 1/3; Erie 3w 680ohms, 1/3 ea.

MICROPHONE capsules, by Standard Telephones, 3/9 ea; hi chokes on ebonite bobbins, 5,000ohms, 1/3 ea. [3816]

SUPREME RADIO, 746b, Romford Rd., Manor Park, London, E.12; est. 15 years; Tel. Ill. 1260; the firm for radio component parts.

MIDGET 0.0005 2-gang condensers with trimmers, split vanes, fixing buta, 12/6; Midget coils, a.h.f.m.w., high gain, t.r.f., with circuit, 8/6; m. and l., 10/6; Midget dials, m.w., 4in x 3 1/2in, 1/9; slow motion drives, 1/-; Midget speakers, 3 1/2in, less tran., 25/-, with tran., 30/-; 6 1/2in p.m., less tran., 22/6; mains droppers, 0.2a 4/6, 0.3a 5/3; line cord, 60 ohms per ft, 2-way 4/6, 3-way 5/6 yard; v.c.s. with switch, all sizes 5/3, long spindle; less sw, 4/-; 2,000-10,000 wire wound controls, less switch, 4/-; mains transformers for all sets, from 22/6; chokes, Midget type, 60 mls, 6/6; heavy duty, 10/6; speaker pot re-winding, etc., trimmers, 40 pots, 9d. each; l.f. trans., new, clearance line, 1/- each, 10/- doz; cabinet, strong metal, 8in fitting, 17/6; bias condensers, all sizes; resistances, all sizes in stock; special line in pkts. wire wound colour coded resistances, assorted, 200-140,000 ohms, 25v in pkt, 7/6; condensers, 0.1-0.1 mfd 250v, w.d.c. 350v w.a.c., 1/6 each; 0.01 Mansbridge condensers, to clear, 4/- doz; h.t. anchoring tags, 2/- doz; rubber grummita, assorted, 3d. doz; American l and m. coils, 3/6; reaction condensers, 0.0005mfd, 2/3; 1 watt 1/2 meg, 20,000 ohms resistances, 4/6 doz; 6v 3a pilot bulbs, 9d. each or 8/- doz. MANY other lines; send s.a.e. for list and enquiries; 6d. extra for post and packing orders under £5; no c.o.d. [3907]

RESISTORS, 1/4w 4d., 1/2w 6d., 1w 9d.; 50 asstd. 1w, 1/2w and 1/4w, 17/6.

CONDENSERS, tubular, mica and s. mica, 0.0001 to 0.0005 9d., 0.01-0.05 1/-, 0.25 1/6, 0.5 2/6, 0.1 9d.; 50 asstd., all types, £1. MAINS droppers, 750 ohms 0.3 amp 5/6, 850-1,000 ohms 0.2 amp 4/6, with sliders and feet; line cord, 0.2 or 0.3 amp, all 180 ohms yd., 2-way 5/-, 3-way 6/- yd.

ALL smalls, solder, wire, sleeving, flux, knobs, tags, ins. tape, irons. SEND 1d. list, 4 pages; transformers, chokes, mikes; books, Radio Test Gear 1/6, Radio Pocket Book 1/-; much useful data; Radio Valve Manual 3/6, Radio Circuit Manual 2/-, Amplifier Manual 2/-; c.o.d. available; post extra.

RADIO SALES, BCM/SALES, London, W.C.1.

HENRY'S offer 16mfd. x 16mfd. 450 volts wkg., 13/6; 25mfd. x 25v. wkg., 2/-; 2mfd. 1,000v. wkg., 7/6; 1,000mfd. 25v. wkg., 10/-; 0.1 tub 1,500v. wkg., 1/6; 0.1 350v. wkg., 8/- doz.; 3-way line cord, 0.3 amps., 3/- yd., 50-60 ohms per ft. 465 l.f. transformers, small cans, litz-wound, 15/- pr.; Celestion 8in P.M., less trans., 21/-; 6 1/2in P.M., with trans., 25/-; Goodmans 3 1/2in, with trans., 35/-; 5in P.M., with trans., 29/-; med. and short wave 465 w./het. coils, serial and osc. with circuit, 12/6; single-pole 11-way switches, 4/6; T.R.F. coils, condensers, valves and chassis in stock; send for lists.

HENRY'S, 5, Harrow Rd., Edgware Rd., Paddington, London. Tel. Pad. 2194. [3925]

LASKY'S RADIO

Are able to supply from stock immediately the following first class and brand new radio and electrical components

SPECIAL KIT OFFER, ONE MONTH ONLY

30 Assorted Condensers, consisting of 3 only 8-mfd. tubulars, 600 volt w. One 16-mfd. 450 volt (Wet can) 2 only 4 mfd. 650 volt w., and 2 mfd. 750 volt w. block paper condensers. 1 mfd. 600 volt w. etc., all new and tested, satisfaction or money back guarantee. £2.15.6. Post free.

SPEAKERS.

Rolls 5in. P.M., 21/6; 6 1/2in. P.M., 22/6; 8in. P.M., 23/6. Goodman's 3 1/2in. P.M., 29/6; 5in. P.M., 21/8; 8in. P.M., 25/6. Goodman's 10in. P.M., £2.7.6, complete with universal trans.

LARGER SPEAKERS IN STOCK. PRICES ON APPLICATION.

Volume controls, all values, long spindle, less switch, 3/9, with switch, 5/6.

Mains droppers, 2 and 3 amp., with fixing feet, 1,000 ohms, 5/6. Line cord, best quality 2- and 3-way 75 ohms, per foot, 3/3 yard.

MAINS TRANSFORMERS

Primaries, 200/250 v., Secondaries, 350-0-350 v. Type (A) 80 m.a., 4v. 3 amp., 4v. 2 1/2 amp., 25/6, shrouded with fixing feet. (B) 100 m.a., 6.3v. 4 amps., 5v. 2 amp., with feet 32/6. (C) 120 m.a., 4v 4 amp., 4v. 2 1/2 amp., with feet, 35/6. And other type, in stock. Price, etc., on application.

TUNING CONDENSERS

.0005 Midget, 2- and 3-gang, less trimmers, 12/6. .0005 Midget 2- and 3-gang, with trimmers, 14/6. .0005 Midget 2-gang condensers with ceramic trimmers and fixing feet, slow motion drive and medium and short wave dial, 18/-. Tackle switches, 2gm 1/9 each, T.R.F. Coils with circuit medium wave type, 6/6 pair. Very high gain. Medium and Long Wave Coils, with circuit, T.R.F. type, 10/6.

VALVES. We have over 7,000 new American and English mains and battery valves in stock at B.U.T. list prices. Send us your requirements. C.O.D. pro-forma, or cash with order. Send 1d. for our price list of all goods.

LASKY'S RADIO

364, 370, Harrow Road, London, W.9



15, SILVERDALE
LONDON, S.E.26

WE LOOK FORWARD
to the time
when private enter-
prise is again free to
'lift' life above the
utility level.

**VOIGT
PATENTS LTD.**

*just because they
give no trouble—
don't forget*

DALY

ELECTROLYTICS

—they're serving you well!

DALY (CONDENSERS) LTD

Condenser Specialists for over 20 years
West Lodge Works, The Green, Ealing, W5
Telephone Ealing 4641

**LONDON CENTRAL
RADIO STORES**

NEW!

THERMO-COUPLE AMMETER, 0-5 amps., 2in. clear reading dial, flush mounting, 35/-.

D.C. Moving Coil MILLIAMMETERS. 0-1 mA., 2in. clear reading dial. Flush mounting, 50/-.

0-25 mA, 2in. dial. Flush mounting, bakelite case. Made by Ernest Turner Electrical Instruments Ltd., 50/-.

0-6 mA, 2in. dial. Flush mounting, bakelite case. Extra scales for conversion to voltmeter and ohmmeter. Internal resistance, 250 ohms, 50/-.

MICROAMMETER, 0-500, 2in. dial. Flush mounting, bakelite case, £4 10s.

GOODMANS 3 1/2in. P.M. Speaker. New, 30/-.

A PARCEL OF CONDENSERS containing 4 each Tubular .1, .01, .001, .005, .0003, .0005, .0064, .004, .0025, .002 mfd. 1 each Electrolytic 8 mfd., 8x8 mfd., 16 mfd. 450 v. wkg. 1 + 1 + .1 mfd. 350 v. wkg. All new. The lot, 45/-.

WIREWOUND POTENTIOMETERS. 25,000 ohms. Tropical type, enclosed in bakelite moulding. Ex-R.A.F. 1/2in. spindle. 1 1/2 x 3/4in., 5/6, or lots of 6, 30/-.

6-way PUSH-BUTTON UNIT MECHANISMS, without buttons or esutchcheon, 3/6.

CHASSIS, 11 x 9 1/2 x 2 1/2, 3/6. For other components and accessories please see previous issues.

**23, LISLE STREET
LONDON GERard 2969 W.C.2.**

PEMBROKE STREET, N.I.

By order of Electrical Sound & Television Patents Ltd. Surplus to requirements.

Messrs.

**FULLER, HORSEY
Sons & Cassell.**

are instructed to offer for sale by Auction in lots at the Baltic Exchange, St. Mary Axe, E.C.3., on Tuesday July 10th, 1945, at 11.0 a.m.

**The Modern
ENGINEERING PLANT**

including Surface Grinders by Lumsden, Jones & Shipman, and Snow, Motorised, all-gear S.S. & S.C. Lathes, Capstan Lathes, Mann Horizontal Miller, C.V.A. Vertical Miller, Shapers, Drills, Filing and Sawing Machines, Power Presses 8/40 tons by Taylor & Challen, and Edwards, 60" Power Guillotine, two Brayshaw Annealing Furnaces with auto controls, two Electric Sherardising Furnaces, two Brayshaw Gas Ditto.

GENERAL EQUIPMENT

including Welding Plants, Plating Plants, De-greasers, 60 electric Motors, Precision Measuring Tools, Steel Office Furniture, Refrigerator, Weighing Machines, Morris 10 cwt. Van and numerous other effects.

Catalogues (price 6d. each) on application from

**Fuller, Horsey, Sons & Cassell,
Industrial Auctioneers,**

**10, Billiter Square, London, E.C.3.
Telephone No. : Royal 4861.**

DARK RADIO OF MANOR PARK have off priority a wide range of meters suitable for making up into multimeters or valve voltmeters; write for advice in you intend making up any test gear.

VALVES at B.o.T. list prices.—Brimar, Coscor, Dario, Ever Ready, Ferranti, Hivao Midgots, Lissen, Marconi, Ostram, Mazda, Mullard, Philips, Triotron and Tungstren, Brivaron and American; all valves tested before despatch; we specialise in matched pairs of PX4s, 6V6s, etc.; no stock of 3Q5, 12A7, 50L6. **TUNGSTEN** contacts for Philips (tubular type) converters, set of 9, 3/6.

METAL rectifiers, 1 to 5ma, 10/-; 5 to 10ma, 15/6. for converting dc meters to read ac.

WOLF electric drills.—Up to 1/4in drill, £8/8; 3/8in drills, £10/10; 1/2in drills, £15/10; 6in bench grinders, £11/17/6; heavy duty Sanders, £13/10; write for illustrated list, s.a.e. **STEP-DOWN** transformers or up.—200-250volts in, output tapped at 3, 4, 6, 7, 8, 9, 12, 13, 15, 21volts at 2amps, transformer is housed in metal case and is suitable for working model trains, 35/6.

REPLACEMENT coils for Marconi or H.M.V. gram. motors, induction type, field coils, 10/6 per pair; current coil, 9/-.

MOVING coil microphones, 37/6; matching transformer, 12/6.

TWIN gang 0.0005 condensers with trimmers. drum drive, engraved dial plate and pointer for midget receivers, 15/6.

RESISTANCE wires.—Send for list giving ohms per yard and centimetre, and wind your own resistances; quantities from 1/2oz supplied.

ENAMELLED wires.—Send for list giving yards per lb and ohms per yd and wind your own bobbins; quantities from 2oz supplied.

RESISTANCE and capacity bridges, £15/15; accuracy ± 2%; descriptive leaflet upon request.

TWIN lead and tough rubber cables, no permit; send s.a.e. for lists.

COMPLETE stocks of all radio and electrical gear carried; sent for list.

PARK RADIO OF MANOR PARK—Sales: 676, Romford Rd., London (Manor Park), E.12. Hord 2066, telephone or grams. Service and technical: 212, High St. N., East Ham, E.6. Grangewood 0213, telephone or grams. [3950]

BATTERY charger kits and rectifiers, mikes, transformers, electrolytics, metal rectifier, 2v 0.5a type with transformer, makes ideal trickle charger for 2v wireless cell, with circuit; 13/6, post 7d.

METAL rectifier, 12v 2.5a type, with transformer and ballast bulb for 2v to 12v charger, 46/6; rectifier only, 22/6, postage 8d. As above but for 2v-6v only, 39/6, post 10d; rectifier only, 11/6, postage 7d.; metal rectifier, 12v lamp, with transformer and ballast bulb for 2v to 12v charger, 32/6, postage 9d; rectifier alone, 9/6.

12V 4amp rectifier with transformer (120-watt), for 6v-12v charger £4, post 3/-, extra for 5amp rectifier, 10/-. Instrument rectifiers for meters, bridge type, bakelite, very good make, new rods, 1mA and 5mA, 18/6; 10mA to 50mA 15/6; no a few only, Hunt's 8mtds. 450v surge proof electrolytic, tubular type, 6/9 ea.

METAL rectifier, 12v 1.5amp. with transformer and ballast bulb for 2v to 12v charger, will charge six cells at 1.4amp, 35/-, postage 10d; also a similar kit to charge three to twenty cells at lamp, ideal for the small radio store, £5/10; metal rectifier, 12v. 3amp, with transformer for 12v charger, 50/-.

METAL rectifiers of various ratings in stock suitable for converting valve type chargers to metal rectification, up to 40v. 5amp, half watt or centre tap types.

ROTHERMEL D.104 crystal microphones, a really first-class crystal mike at a reasonable price, £4/10; mains transformers for amplifiers, 120-watt size, weight 15lb, 400v-0-400v, 120mA, 6.3v and 5v, suit 6L6 tubes, 42/6, postage 1/8.

CHAMPION, 43, Uplands Way, London, N.21. Tel. T.ah. 4457. [3851]

INSULATED test prods with removable crocodile attachments, 3/3 complete; speaker gauges, 2/-; many other lines; list 3d., post free.—V.E.S., Radio House, Melthorne Drive, Ruislip. [3936]

SPEAKERS—6in p.m. Celestion with trans., 30/-; 8in p.m. Rola, Celestion, Plessey, less trans., 21/-; with trans. 28/6; Goodmans 3 1/2in. 3 ohm, less trans., 30/-.

VOLUME controls, Centralab, Dubilier, with sw. 5/6, less sw. 4/6; various values.

IP trans., standard size, 465 k/c, 10/- ea.

COILS, all m.w., a.c. and h.l., 4/6 pair; osc., 465 k/c, 2/3 ea.

TWIN gang, 0.0005, small, with trimmers and feet, 15/- ea.

ENQUIRIES invited; please send s.a.e., 1d. s.a.e. for 4-page list; o.o.d. or c.w.o.

RADIO SALES, BCM/BALES, London, W.C.1.

GALPINS

ELECTRICAL STORES

**408, HIGH ST., LEWISHAM,
LONDON. S.E.13.**

**TERMS: Cash with order. No. C.O.D.
All prices include carriage or postage.**

ELECTRIC LIGHT CHECK METERS, first-class condition, electrically guaranteed, for A.C. mains 200/250 volts 50 cy. 1 phase 5 amp. load, each 12/6.

TUNGSTEN CONTACTS, 1/2in. dia., a pair mounted on spring blades, also two high quality pure silver contacts, 1/2in. dia., also on spring blades, fit for heavy duty, new and unused. There is enough base to remove for other work. Set of four contacts, 4/-.

ROTARY CONVERTER, input 40 volts D.C., output 75v., 75 mA/A., A.C., also would make good 50v. motor or own generator. £2.

AUTO TRANSFORMERS. Step up or down, tapped 0-110-200-220-240; 1,000 watts. £5.

POWER TRANSFORMER, 4kW, double wound 400 volts and 220 volts to 110 volts, 50 cycle, single phase. Price £20.

AUTO TRANSFORMER, step up or step down, 500 watts, tapped 0-110-200-220-240 volts. £3 10s.

1/2 WATT WIRE END RESISTANCES, new and unused, price per doz., 5/-, our assortment.

MOVING COIL AMPMETER by famous maker. 2in. dia., flush mounting, reading 0-10 amps. F.S.D., 20 mA/A, price 27/6.

METAL RECTIFIERS, large size, output 50 volt 1 amp., 35/-.

SMALL MAINS TRANSFORMERS, input 230 volts' output 11 volts 1 amp., 11/-.

METAL RECTIFIERS, large size, output 12 volts 1 amp., 17/6.

FIXED RESISTANCES, size 12in. by 1in., fire-proof, resistance 2 ohms to carry 10 amps., 3/- each; set of 16 mounted in steel frame, only 35/-.

TRANSFORMER CORE for rewinding only, complete with clamps, size approx. 2 1/2 k.w., price 25/-.

CABINET LOUDSPEAKER, for extension only, 5 watt output, 8in. dia. cone, high quality, size of cabinet 16 x 14 x 8 1/2in. x 1/2 thick, cabinet slightly marked at top, price £3.

SMALL M.L. ROTARY CONVERTER, in cast ali, case, size 14 x 4 1/2 x 4 1/2in., permanent magnet fields, converters need attention, not guaranteed. 30/-.

POWER TRANSFORMER, suitable for arc welding, input 230v., 50 cycle, 1 PH, output 50 volts at 200 amps., price £17; ditto, output 150 amps., £15; ditto, output 100 amps., £12.

DYNAMO, slow speed, only 500 r.p.m., output 25v.-10 amps., shunt wound, adjustable brush gear, ball bearing, condition as new, weight 80 lbs., a real high-grade job. Price £7 10s.

50 VOLT MOTOR, D.C., input 4 amps., 1/2 h.p., ball bearing, double ended shaft 1/2in. dia., slow speed, only 500 r.p.m., shunt wound, condition as new, also make good slow speed generator. Price 50/-.

AUTO TRANSFORMERS, tapped 0-110-200-220-240v., 1 1/2 KW., £7 10s.; 2 KW., £10.

50 VOLT D.C. MOTOR, shunt wound, ball bearing, 1/2 h.p., speed 900 r.p.m., in new condition, make good generator. Price £7.

MOVING COIL AND M.I. METERS. FOR FULL DETAILS OF ABOVE AND OTHER GOODS, SEND FOR LIST, 2/6.

ELECTRADIX OFFERS!

Laboratory and Test Gear
MEGGERS. Evershed Bridge Meggers with Resistance box, as new, but store-soiled cases, few only.
RADIOGONIOMETER Direction Finders, in polished case, £4 10s.
GALVANOMETERS, Tinsley M.C. Ballistic, Vertical Mirror Reflecting type, 100 ohms, £5 10s. Sullivan Marine Reflecting Galvo., with M.C. Suspension, £9 10s.
RELAYS. Siemens' High-speed Relays in heavy brass case, £3 5s. Telephone type No. 6. 2-coil polarised. I.P.C.O.. 6 volts 25 ma. 325 ohms, 8s. 6d. No. 1A. S.P. on-off, 2 volts 40 ma., 5s. Relay movements 1,000 ohms, less blade and contact, 2s. 6d.
METERS. D.C. Moving Coil Milliammeter 0-1 ma., 100 ohms resistance, 2 1/2 in. flush panel, bakelite case, £3.
Instrument Rectifier, 1 ma., 10s. 6d. B.S. Sub-Standard M.C. Voltmeter, Sector shape, on polished wood base, Sin. scale heavy bakelite terminals, double reading, 0-15 and 0-150 volts Mirror Scale, Zero adjuster, 6 ma., F.S.D., £5. Portable 3-range D.C. Voltmeter, 4in. x 2in. x 4in.. Zero adjuster, 75-150-300 volts, £5.
TRANSFORMERS. 3 kW. Crypto 230 v. to 115 v., shrouded, £12. 3 kW. Metvick, 50 cy. 400 v. to 600 v., £9 10s. 1 kW. Powquip 50 cy. 250 v. to 50 v., 20 amps., £9. 500 watt Foster 50 cy. 440 v. to 110 v. 5 amps., £4 15s. 150 watt Foster 400 cy. 230 v. to 15 v. 10 amps., £2 15s. 5 watts H.T. test Transformers 110/220 v. to 1,000 v. 5 ma., 10s. Current transformers for meters. Various sizes in stock.
TRANSFORMERS, FOR RE-WIND 3 kW. New type with stampings 4 1/2 x 6 x 7 1/2 in., windings damaged by blitz. Can be taken apart to make a number of smaller units. Weight with damaged wire is 65 lbs. Limited number at 45s., carriage extra.
 Please include postage for mail orders.

ELECTRADIX RADIOS

214, Queenstown Road, Battersea, London, S.W.8
 Telephone MACaulay 2159

**YOU
 can become
 a first-class
 RADIO
 ENGINEER**

We are specialists in Home-Study Tuition in Radio, Television and Mathematics. Post coupon now for free booklet and learn how you can qualify for well-paid employment or profitable spare-time work.

T. & C. RADIO COLLEGE
 2 The Mall, Ealing, W.5

(Post in unsealed envelope, 1d. stamp)

Please send me free details of your Home-Study Mathematics and Radio Courses.

NAME

ADDRESS

RESISTORS, colour coded, wire wound, brand new; good assortment from between 100 ohms to 140,000 ohms; 24 in packet, 6/6, post paid.—Lawrence, 52, Church Rd., Manor Park, London, E.12. [3906

RUSSELLS RADIO offer 11 transformers, 465, K.C.S., iron cored, 16/- pair; aerial and h.f., 5/- pair; new type suppressor, 6/-; O.P. transformer, 8/6; all goods guaranteed; add 9d. for postage.—Russells, 22a, Palmerston Rd., Boscombe, Hants. [3860

BUY your components direct, and save pounds. Build our M.W. Super Victory Four. Highly assessed users everywhere; circuit, drilled chassis, brackets, rivets, and everything to build this excellent 4v ac/dc set is supplied for £7/19/6; cabinets, £2/2; detailed circuit separately, 1/6; chassis, 4/6; chassis, valveholders, speaker, 2-gang condenser and dial, all assembled, £2/19/6; dial MW/8W; gold/black, punched for dial lamp, 1/-; send 1d. for interesting lists.

BUCCLEUCH RADIO MANUFACTURERS. 2 and 2, Melville Terrace, Edinburgh.

COTTON-COVERED copper instrument wire. 1/2 lb reels, 18, 20, 22, 24 gauges, 1/6; 26, 28 gauges, 1/9; 30, 32g, 2/-; 34g 2/3; silk covered ditto, 2oz reels, 24, 26, 28g, 1/6; 30, 32, 34, 36g, 1/9; 42g, 2/1; 16g double silk, 1lb, 5/-; B.A. thread screws, 1 gross useful sizes, 2/6; ditto, nuts, 2/6 gross; assorted gross screws and nuts, 2/6; ditto, brass washers, 1/6 gross; fibre washers, 1/6 gr; assorted solder tags, 2/- gr; assorted small eyelets and rivets, 1/3 gr; rubber-covered stranded copper wire, 1d yard; heavier quality, 1 1/2d. yd; very heavy quality, 2 1/2d. yd; ideal for aeriels, earths, etc.; tinned copper connecting wire, 20ft coil, 6d.; ditto, rubber covered, 10ft 6d.; finest quality push-back wire, 12 yds, 2/3; single cotton covered tinned copper wire, 25g, 12 yards, 9d.; 50 yds, 3/-; twin bell wire, 12 yds, 1/9; heavier quality, 12 yds, 2/3; flat rubber-covered ditto, 3d. yard; twin flat braided electric cable, 6d. yard; all postage extra.—Post Radio Supplier, 33, Bourne Gardens, London, E.4. [3593

THE Simplex Four, complete constructional details of this most successful midget ac/dc receiver (total cost of construction £9), including theoretical and full scale layout wiring diagrams, with instructions, 4/6; midget high gain medium wave T.R.F. coils, 7/6 pair; short wave, aerial and oscillator coils, 1/6 at 465 k/cs, 5/6 pair; ditto m wave coils, 7/6 pair; midget 2-gang variable 0.0005mfd condenser, 13/6; Simplex midget chassis for the 4-valve midget, all component fixing holes, finished in electro zinc, 11x4 1/2x2 1/2 in., a professional job, 7/6; midget m wave dials, station names, etc., ivorine, 4x3 1/2 in, 1/6; midget smoothing chokes, 50.60 ms, 6/-; midget power pen, speaker transformers, 6/6; push button units, 6-way, escutcheon, knobs, 5/6; Celestion B in p.m. with tran., 2/7/6; 6 1/2 in ditto, 25/-; 10 1/2 in ditto, 35/-; R. & A. 5in M.F. speaker with tran., 1,200ohms, 35/-; mains transformers, Marconi, new, 350-350, 5v and 6.3v l.t., 30/-; heavy quality amplifier cases, comprising chassis and perforated detachable cover, chassis, 17 1/2 x 8 1/2 x 2 1/2 in, undrilled, height of cover, 7 1/2 in, sprayed dark battleship grey, ideal housing for quality amplifiers, 57/6; mains droppers, 0.3amp, 5/6; vol. controls, long spindle with sw., 10,000, 50,000 ohms, & 1 & 2 meg., 6/6; comprehensive lists monthly, 2/6; s.a. e. enq. please; send all orders.—O. Greenlick, 34, Bancroft Rd., Cambridge Heath Rd., London, E.1. Ste. 1334.

TELE-RADIO (1943), Ltd., for brand new good quality components at manufacturers' list prices. Suppliers to professional constructors and amateurs who want only the best. Weston meters, 250 micro amps, centre zero reading, £3/5; 0-1mA, £2/10; 0-500 micro amps, £3; 0-100 micro amps, £3/15; 0-50 micro amps, £4/10; 1mA instrument rectifiers, 12/6; spot-on wire wound precision resistors, plus or minus 0.05%, 5/6 each (up to 50,000 ohms only); single-pole 12-position switches, 3/6 each; 4-pole 3-way, 3/6 each; cathode ray tubes, G.E.C. 1 1/2 in, £2/15; Cosor 23D, 2 1/2 in, £3/6; Cosor 26D, 4 1/2 in, £6/10; Cosor GDT4B gas-filled triode, 24/4; high-voltage rectifiers and condensers; potentiometers carbon 4/6; with switch, 6/6; wire wound, 6/6, all usual values; crystals, 100 Kcs, 45/- (P.O. permit); Rothermel crystal pick-ups, £3/13/6 and £3/18/9 (high fidelity Red Label 10/- extra); Celestion and Vitavox speakers; 0.0005 2-gang condensers, ceramic insulation, with s.m. drive, 16/6; wave-change switches, variable condensers and trimmers, etc.; comprehensive stocks of British and American valves; steel racks, chassis, panels and cabinets, any specification (caller only); postal enquiries acknowledged same day; cash orders, if in stock, 24 hours' service; postage and packing extra on all goods.—Tele-Radio (1943), Ltd., 177a, Edgware Rd., London, W.2. Tel. Pad. 6116. [3898

THESE ARE IN STOCK

ELECTRONIC EQUIPMENT AND ACCESSORIES.
 By R. C. Walker, B.Sc., A.M.I.E.E., A.M.I.M.E. 25/- Postage 6d.
TIME BASES, SCANNING GENERATORS.
 By O. S. Puckle, M.I.E.E. 16/- Postage 5d.
WIRELESS WORLD VALVE DATA.
 Operating condition and base connections of the principal types and makes. 2/- Postage 2d.
WIRELESS SERVICING MANUAL.
 By W. T. Cocking, A.M.I.E.E. 7/6 Postage 4d.
TELEVISION RECEIVING EQUIPMENT.
 By W. T. Cocking, A.M.I.E.E. 10/6 Postage 4d.
THE AMPLIFICATION AND DISTRIBUTION OF SOUND.
 By A. E. Greenless, A.M.I.E.E. 12/- Postage 6d.
THEORY AND DESIGN OF VALVE OSCILLATORS.
 By H. A. Thomas, D.Sc., M.I.E.E. Vol. VII. 21/- Postage 5d.
THE MATHEMATICS OF WIRELESS.
 By R. Stranger. 7/6 Postage 4d.
 We have one of the Finest Stocks of Technical Books in the Country.
THE MODERN BOOK CO.
 (Dept. W.4), 19-23, Praed St., London, W.2.

Improved Germinal CLIPS



Well made of steel, double ridged for strength. Teeth on three sides of lower jaw and special design of upper jaw ensure firm grip and good contact.



CHURCH ROAD · HENDON · LONDON · N.W.4

DUAL TESTOSCOPE



This new dual model indicates 2 to 30 volts and 100 to 750 volts.
 Good allowance for your old charger
 Send for interesting leaflet (R.14) on "Fastine".

RUNBAKEN-MANCHESTER

BERRY'S (SHORT WAVE) LTD.

A MOST COMPLETE LIST W.W.

RADIO & ELECTRONIC EQUIPMENT

will be sent on receipt of stamped envelope

25, HIGH HOLBORN, LONDON, W.C.1
 (Tel: HOLborn 6231)

SELECTIONS from our NEW MAIL-ORDER LIST W/W JUST PUBLISHED.

CABINETS. Instrument type cabinets in 18-gauge steel with 18in. x 9 1/2in. x 3 1/2in. chassis finished in black or grey ripple enamel, 63/-. Two other sizes available, also un-drilled chassis and panels. International transmitter panels in 18-gauge steel, black ripple finish, un-drilled. Three sizes, 10 1/2in., 8 1/2in. and 7in. by 18in. Complete racks with 3 1/2in. x 10in. of panel space, 47/6.

A.C. 3-WAVEBAND CONSTRUCTORS KIT. Everything for a Super Receiver with full instructions, £11 17s. 6d. Also 3-Waveband battery type and Universal T.R.F.

HEAVY DUTY CHOKES. 30 H 150 m.a., 200 ohms, 17/6. 20 H 250 m.a. 500 ohm swinging chokes, 21/-, 25 w. and 50 w. P.P. output transformers. Also Mains, Auto, Multi-Radio and Intervalve Transformers.

WEARITE PRODUCTS. Type "P" coils. A complete range of these coils is available. 12-3,000 metres continuous tuning. Also miniature I.F. Transformers, Beat Frequency Oscillators, Oak and Malloy replacement Vibrators 6 or 12 volt. We can supply ceramic or mica compression type trimmers for above coils.

VOLUME CONTROLS. High-grade components, 5,000 ohms to 2 megohms, 5/9. Less switch, 3/9.

CONDENSERS. 0.0005 2-gang condensers with slow-motion drive, 18/6. T.C.O. metal-cased block type condensers 4 mid. 500 v., 4 mid. 1,500 v., 8 mid. 500 v. All types of electrolytics, cardboard case and can from 2 mid. to 32 mid., 250 v. to 900 v. Also bias types. Small tubular, silver mica and ceramic cup and disc from 5 pf. to 0.5 mfd.

CARBON RESISTORS. All values, 1 w. at 9d. each, 8/- doz.

PREFECT. Trimmer Tool Kit. 12 tools and extension handles, box spanners and screw drivers. Complete in carrying case, 30/- per kit.

RADIO INSIDE OUT. Complete serviceman's guide, 4/8. **TECHNICAL PUBLICATIONS.** American Service Manuals—volumes 1 to 6 at 12/6 per volume. 75/- the set, post paid. Amplifier Manual, 2/3. Radio Valve Manual, 3/8. Radio Circuits, 2/3.

Send 2jd. for New List W/W.

EXCLUSIVELY MAIL ORDER

WAVEBAND RADIO LTD.

63, Jermyn St., St. James' St., London, S.W.1.



FOR THE RADIO SERVICE MAN, DEALER AND OWNER

The man who enrolls for an I.C.S. Radio Course learns radio thoroughly, completely, practically. When he earns his diploma, he will KNOW radio. We are not content merely to teach the principles of radio, we want to show our students how to apply that training in practical, every-day, radio service work. We train them to be successful!

Special terms for members of H.M. Forces and discharged members of H.M. Armed Forces.

INTERNATIONAL CORRESPONDENCE SCHOOLS

Dept. 38, International Buildings, Kingsway, London, W.C.2

Please explain fully about your Instruction in this subject marked X.

Complete Radio Engineering
Radio Service Engineering
Elementary Radio Television

And the following Radio examinations:
British Institution of Radio Engineers
P.M.C. Certificate for Wireless Operators
City and Guilds Telecommunications
Wireless Operator & Wireless Mechanic, R.A.F.

Name.....Age.....
Address.....

COULPHONE RADIO. Station Rd., New Longton, nr. Preston.—New goods only of the highest quality; all orders attended to same day as received; note price reductions on many lines, and remember that all orders over 5/- are post free; electrolytics, 8x450v 8/9, 8x8 450 12/6, 2x350 3/6, 25x25 and 50x12 2/6, 25x50 3/-, 50x50 3/3; Rola, Plessey, Goodmans and Celestion speakers, p.m., less trans., 3 1/2in 29/-. 5in 21/-. 6 1/2in 21/6, 8in 22/6, 10in 35/-; with trans., 6 1/2in 27/-. 8in 27/6, 10in 42/6; Vitavox super quality 12in p.m. K12/10, £6/13; mains transformers, screened primary, 200/250v, 350/0-350, 100ma, with 4v or 6v l.t.s, 28/6; bob-bins only, 15/6; 425/0-425, 200ma, 4v 8s, 4v 4s, 4v 4a or 6.3v 4s, 6.3v 4s, 5v 3s, 47/6; 20 hy 200ma chokes, heavy duty, 21/-; speaker transformers, push pull universal types, 4watt 8/6, 8w 12/6, 15w 21/-, 30w 37/6; Midget pen, 5/-; dropper resistors, 800 Ω 0.3a, with feet and two sliders, 4/6; push-back wire (Henleys), 50ft 2/9, 100ft 4/9; Delaflex 2mm sleeving, 2/- dozen; valve-holders, 5, 7, 9 pin English, Mazda octal, 4, 5, 6, 7 pin UX and Int. octal, all types 6d. each; resin-cord solder, 4/- lb.; 3-way cable, 6d. yd, 5-way 10d.; line cord, 60 yd per foot, super quality, two or three-way, 3/6 per yard; vol. controls, long spindle, all sizes, 5,000 to 1 meg, less switch 3/6, with switch 4/9; precision B.S. 1st grade 0-1ma m.c. meters, 4 1/2in dia, knife edge pointer, 70/-; 8in energised speakers, 1,200 Ω field, pen trans., 32/6; wartime battery receivers, £10; mains, £11; carbon resistors, 50 Ω to 5 meg, 1/2w 6d., 1w 8d.; Polar 2-gang (small) tuning condensers, 0.0005, with trimmers and feet, Ceramic, 11/6; s.a.e. for comprehensive list.

WANTED, EXCHANGE, ETC.

ANY disc recording gear required.—Glen Bamber, BM/K93R, London, W.C.1

WANTED, station scale for Ekco A.W.108.

WTD, elect. gram. motor, with p.u. pref., or Garrard auto-changer, also Hartley Turner speaker.—Box 3478. [3912

WANTED to purchase, quantity used glass recording blanks, Simplat type.—Gamble, 69, Letchworth Rd., Leicester. [3930

OSTAR-GANZ V3 (h.t. pentode), 220-240v, must be good condition.—Burghope, 25, Harrington Villas, Brighton, 6. [3916

WE offer cash for good modern communication and all-wave receivers. — A.C.S. Radio, 44, Widmore Rd., Bromley. [1541

WTD, H.R.O. PW-0 dial, with or without condenser, your price paid.—G2WZ, 13, Tretawn Gardens, N.W.7, Mill Hill 4400.

WTD, 2 or 3 fuses, W/WO, 8in, 15Ω P.M.s. ex. 110v. a.c., G.R. motor, "Thor" spray gun, or cash.—26, Sundorne Ave., Shrewsbury. [3862

NEW boxed valves wanted, any quantity, dealers' and service men's complete stocks bought.—J. Bull and Sons, 246, High St., Harlesden, N.W.10. [2155

WE buy for cash, new used, radio, electrical equipment all types; especially wanted, radios, radiograms, test equipment, motors, chargers, recording gear, etc.—If you want to sell at the maximum price, call, write or phone to University Radio, Ltd., 22, Lisle St., Leicester Square, W.C.2. Ger. 4447.

CAPACITY available for complete manufacture of all types of radio and electrical equipment; wave winding, coil and transformer winding, with vacuum impregnation, Ministry super tropical standards; A.I.D. approved. GREEN ELECTRICAL INDUSTRIES, Ltd., 44-45, Tamworth Rd., Croydon. Tel. Croydon 7417-8. [3893

WANTED urgently, complete copies of all back numbers of monthly issues of "Wireless World," weekly issues Nov. 1937, to Dec., 1938, also "Radio Designer's Handbook" and "Radio and Telecommunications Engineer's Design Manual"; state prices.—E. K. Pooley, 16, Rectory Rd., Orford, Woodbridge, Suffolk. [3919

REPAIRS AND SERVICE

TRANSFORMERS of all types built to performance specification.—Phillips, 1, Lister Gardens, London, N.18. [3859

REWINDS and conversions to mains and output transformers, fields, etc., from 4/6.—N.L. Rewinds, 4, Brecknock Rd., N.7. [3915

MAINS transformers rewound and constructed to any specification; prompt delivery.—Brown, 3, Bede Barn Rd., Jarrow. [3460

"SERVICE with a Smile."—Repairers of all types of British and American receivers; coil rewinds; American valves, spares, line cord.—F.R.I., Ltd., 22, Howland St., W.1. Museum 5675. [1575

MAINS transformers service, repairs, rewinds, or construction to specification of any type, competitive prices and prompt service.—Sturdy Electric Co., Ltd., Dipton, Newcastle-upon-Tyne. [3084

NOW



BLUE PRINTS

of the following circuits. Theoretical and Practical. 2/6 per set of 3 (1 Theo. and 2 Prac.). No. 1. A.C. T.R.F. 3 valves, Medium Wave only. No. 2. A.C. T.R.F. 4 valves, Long, Med. & Short. No. 3. A.C. T.R.F. 4 valves, Short Wave only. No. 4. A.C. Superhet 4 valves, Short and Med. waves. No. 5. A.C./D.C. Superhet, 4 valves, Short and Medium Wave. No. 6. A.C./D.C. Superhet, 4 valves, Short and Medium Wave. No. 7. Battery T.R.F. 3 valves, Long, Medium and Short Wave. No. 8. Battery T.R.F. 4 valves, Long, Medium and Short Wave. No. 9. Battery T.R.F. 3 valves, Short Wave only. No. 10. Battery T.R.F. 4 valves, Short Wave only. No. 11. Battery 2 1/2 watt Amplifier, 3 valves Push Pull. No. 12. A.C. Superhet, 5 valves, Ultra Short and Short Waves, 5-100 metres. No. 13. A.C. Superhet, 7 Valves, 5-750 metres. No. 14. A.C./D.C. Superhet, 5 Valves Ultra Short and Short Waves, 5-100 metres. No. 15. A.C. Superhet, 7 Valves, 5-750 metres. No. 16. A.C./D.C. Superhet 7 Valves 5-750 metres. Priced list of components sent with each set of Blue Prints.

4-VALVE, 4-WATT

GRAMOPHONE AMPLIFIER CHASSIS

Assembled on black Crackle-finished chassis fitted with separate Tone Control, Volume Control with on/off switch, sockets for microphones, gramophone and extension speaker. Hum free, good quality reproduction. A.C. only. Input 200/250 v. 5ire overall, 8 x 6 1/2 x 7 1/2in. Ready to play. Price, 10 Gns. including valves and speaker. Theoretical and practical Blue Prints of the above available separately. 3/6 per set.

MAINS TRANSFORMERS

Primary, 10-0-200-220-240; screened primary; H.T. 375-0-375 at 175 ma.; LT1, 5 v. 2 a.; LT2 6.3 v. 4 a.; LT3, 6.3 v. 4 a. Price 52/6 each, post 1/1. 350-0-350; 150 ma.; L.T.S. 6.3 v. 5 a.; 4 v. 4 a.; Rec. 5 v. 2 a.; 4 v. 2 1/2 a.; can be used with international or English valves. Colour coded. Mains Input tapped 900/220/240 A.C. 50/-, post 1/1. 400-0-400; 120 ma.; L.T.S. 4 v. 2 a.; 4 v. 4 a.; 4 v. 2 a.; 4 v. 2 a.; long Colour Coded Leads with high insulation. (900/220-240) Mains Input Tappings 45/-, post 1/1. 350-0-350, 80 ma.; 4 v. 4 a.; 4 v. 2 a.; A.C. Mains Input 110 v. 225-240 v. 30/-, post 8d. 300-0-300; 80 ma.; 4 v. 4 a.; 4 v. 2 a. A.C. Mains Input 230, 30/-, post 8d. 350-0-350 Chassis Mounting, Shrouded, 4 v. 4 a.; 4 v. 2 a.; Input 200/230/240, 35/-, post 8d. 300-0-300, 75 ma., Chassis Mounting, Shrouded, 4 v. 4 a.; 4 v. 2 a.; Input 200/230/250, 37/6. Mains Transformers, wound to specification.

FUSE-FULL Input Transformers, heavy duty. Split secondary windings ratio 4:1. Price 12/6. Small for Parallel Feed Standard, 6/-.

OUTPUT TRANSFORMERS. Standard Pentode midget, 3 ohms, 7/6. Pentode small, 8/6. Multi-ratio, standard, 12/6.

CONDENSERS. 2-gang, small, 2 trimmers, fixing brackets, .0005 Ceramic insulation, 15/-.

SHORT WAVE TUNING CONDENSERS, .00016, .0002 4/6 each. REACTION CONDENSERS, .0003, .0005, .0005, .00015; Differential .0003, .0005, 3/-.

I.F. TRANSFORMERS. 465 K.C.B. Small screened, 15/- pair. Trimmers. Single Ceramic, postage stamp type, 30 pf., 8d.; 30/50, 100/125, 150/250, 180/200, 1/- each. Silver Mica Condensers, wire ended, 40 pf., .00015, etc., 9d. each.

Mains Dropping Resistors, with variable tappings, 2 a., 1,000 ohms, 6/-; 3 a., 750 ohms 7/- each. Wire Wound Resistors, 500, 1,000, 10 watt, 2/6 each.

Toggle Switches. Miniature on-off, single pole, 2/6. D.F., D.T., 4/3.

Metal Rectifiers, small, chassis mounting 45 valve 40 ma., 7/6 each.

Chassis, silver sprayed, un-drilled, 10 x 8 x 2 1/2, 7/6. 8 x 6 x 2 1/2, 4/6.

Orders can be executed for B.L.A., C.M.F. and S.E.A.C. customers.

307 HIGH HOLBORN.
LONDON W.C.1. Phone HOLborn 4631

BERRICON

VALVEHOLDER

*A new development
in Valveholder design*



An enlarged view of the "Berricon" Beryllium Copper Socket, which maintains low and non-varying contact resistance for indefinite periods.

RADIO INSTRUMENTS LTD.
Subsidiary of Aeronautical & General
Instruments Ltd.

PURLEY WAY, CROYDON
Phone: THOrnton Heath 3211.

READY NOW

A new
AMBASSADOR

**AMPLIFIER with
SUPER-HET RECEIVER
GIVING 20 WATTS**
ON MEDIUM & SHORT WAVES

Further details will gladly be
supplied on request. Orders can
only be accepted for Priority
purposes.

R. N. FITTON, LTD
HUTCHINSON LANE, BRIGHOUSE.
Tel: 283. Scottish Distributors
BRITISH ELECTRICAL & Mfg. Co. Ltd.
733, West Campbell St., GLASGOW. Tel. Cen. 3286.

Aladdin
RADIO CORES
for all purposes
GREENFORD, MIDDx. WAXLOW 2300

ACCURATE radio rewinds, mains transformers, fields, op. transformers, etc.—Southern Trade Services, 297-299, High St., Croydon. [2882]

LOUDSPEAKER repairs, British, American, any make; moderate prices.—Sinclair Speakers, 12, Pembroke St., London, N.1 Terminus 4355. [3308]

METROPOLITAN RADIO SERVICE CO. for guaranteed repairs to British and American receivers of all types.—(Service Dept.), 1021, Finchley Rd., N.W.11. [3886]

ALL types of radio receivers serviced; Murphy and Pilot specialist; valves in stock; sound repairs for 13 years.—T. E. Fevver, F.I.P.R.E., 50, Vine St., Uxbridge.

RADIO repairs quickly executed to all makes, English or American; lowest possible prices.—The Music Box, 89, London Rd., London, S.E.1. (Tel. Waterloo 4460 and 6766.)

TRANSFORMER rewinds, special designs manufactured, all types, fields, chokes, outputs, etc.; rewound; moderate charges, quick delivery; guaranteed high-class work.—H. W. Forrest, 67, Burman Rd., Shirley, Birmingham. Shl. 2483. Est. 1922. [3652]

24-HOUR service, 6 months' guarantee, any transformer rewind, mains, outputs and i.f.s, etc., all types of new equipment supplied to specification; business heading or service card for trade prices.—Majestic Winding Co., 180, Windham Rd., Bournemouth. [3592]

TRANSFORMER rewinds and replacement coils, machine layer wound on bakelite formers, interleaved, impregnated and clearly marked, rewinds £1, post paid, standard types to 70 watts; replacement coils, 15/6; larger types and additional secondaries pro rata; discount to trade; delivery by return post; most types in common use; atate model and iron size when ordering coils; cash with order or c.o.d.; fully guaranteed.—Radio Services, Field St. Works, Blackpool, R.T.R.A. Service members. Tel. 1774. [3328]

REWINDS, mains transformers, layer wound, wax impregnated, chokes, O/P transformers, clock coils, field coils, pick-ups, complete repairs, competitive prices, prompt service, 12 months' guarantee; trade queries invited.—W. Groves, Manufacturing Electrical Engineers, 154, Icknield Port Rd., Birmingham, 16.

T—Loudspeakers and service engineers only, or materials supplied; also big stocks of all components; send your trade card or billhead and Id. stamp for our current lists.—A.V.F. Radio Products, Borough Mills, Sharpe St., Bradford, Yorks. [3410]

DEGALLIER'S, Ltd.—"Service with a guarantee." If you cannot get your receiver serviced, let American specialists do the job; first-class workmanship only; specialising in Air-King, Belmont, Challenger, Detroit, deWald, Emerson, Ferguson, Garod, Halcraft, Hamerlund, McMurdo, Med-west, Majestic, Pilot, Philco, Sparton, etc., also any British set. Remember, for 15 years we have handled as distributors American receivers s.a.e. with all enquiries.—Degallier's, Ltd., 9, Westbourne Court, London, W.2.

MISCELLANEOUS

RUBBER stamps.—V. E. S., Radio House, Ruislip. [3209]

WE have facilities particularly suited to this class of work; A.I.D. approved; enquiries to:—

GREEN ELECTRICAL INDUSTRIES, Ltd., 44-45, Tamworth Rd., Croydon. Tel. 7417-8.

CORONA Zephyr Elite portable, latest model, one month's use, as new; £30.—Temple 3628, office hours. [3910]

TIME recorders.—Write for particulars.—Glehill-Brook Time Recorders, Ltd., 84, Empire Works, Huddersfield. [2419]

CHASSIS, brackets, clamps, shrouds, etc., made quickly, accurately with professional finish in A.A. 1800, used by large radio mfrs., invaluable to experimental engineers.—Full details free from A. A. Tools, 197a, White acre Rd., Ashton-u.-Lyne. [3770]

ELECTRIC guitar units, complete constructional details (8 1/2 scap pages plus prints) of three proved and approved electro magnetic units which convert an ordinary guitar to an electric model; my units are being used by professional and amateur guitar players all over the country, 5/-.

ELECTRONIC one-string fiddle, an amazing instrument not to be confused with the old-fashioned type, outstanding response and tone; full details, 3/6.

AC/DC AMPLIFIER, portable, 6-8 watt output 4 valve plus reot. phase-splitter, neg current feed-back, push-pull output, specially designed for use with above instruments, p.u. or mike; full constructional details, 3/6. stamp for full list of data sheets covering tested and guaranteed designs.

SPARKS' DATA SHEETS (W), 9, Phoebe Rd., Brockley, London, S.E.4. [3723]



W. BRYAN SAVAGE LTD.

Expert assistance in the solution of problems relating to

● TRANSFORMERS, CHOKES

● AMPLIFIERS

● POWER UNITS

and Specialised Equipment
embodying

ELECTRONIC CONTROL

**WESTMORELAND RD., N.W.8
CORINDALE 7131**

LONDEX for RELAYS

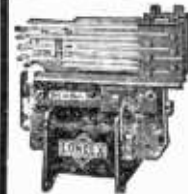

Multiple contact
Relay LF.

for A.C. and D.C.

2 VA Coil consumption from 2 to 600 volts and tested to 2000 volts, Aerial Changer Relays, Mercury Relays, Measuring Relays and Time Delay Relays.

Ask for leaflet
205/WW

LONDEX LTD

MANUFACTURERS OF RELAYS

207 ANCHLEY ROAD, LONDON S.W.10

THE POLYTECHNIC
Regent Street, London, W.1

SCHOOL OF ENGINEERING

Head of School: PHILIP KEMP, M.Sc.Tech., M.I.E.E., A.I.Mech.E.

RADIO ENGINEERING. A Full-Time Day Course in telecommunication, extending over a period of three years, prepares students for the National Diploma and other examinations, and for the radio and telephone industries.

The School re-opens on September 18th, 1945. Early application for admission is advisable.

EVENING CLASSES in these subjects commence on September 24th. (Enrolment: September 17th to 19th, 6-8 p.m.)

Prospectuses, giving full particulars of Courses, fees, etc., may be obtained on application to the undersigned:

J. C. JONES, Director of Education,
The Polytechnic, 309, Regent Street,
London, W.1.

MATRICULATION

Brings Success & Security

Whatever your age, you can now study for the all-important Matriculation Examination at home on "NO PASS—NO FEE" terms. "MATRIC" is the accepted passport to all careers, and opens up opportunities which would otherwise be completely closed to you. Ensure the success and security of you and yours through post-war difficulties by writing for our valuable "Guide to Matriculation" immediately—FREE.

B.T.I. (Dept. 114)

156, Oxford Street, London, W.1.

The "PYROBRAZE"

Electric Brazing and Soldering Unit in Portable and Robust Metal Cases

For soft-soldering heaviest gauges of wire or sheet—where a soldering iron fails. Produces neat joints in half the time.

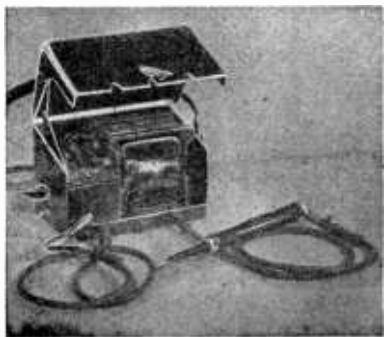

FOR SILVER SOLDERING & BRAZING MEDIUM GAUGES DELIVERY FROM STOCK ASK FOR LEAFLET

The ACRU Electric Tool Mfg. Co. Ltd. 123, HYDE ROAD, ARDWICK, MANCHESTER Telephone: ARDWICK 4284

STUCK!



Should you chance to be one of those unfortunate W/T Operators who, despite hours of long practice, cannot raise your speed beyond a certain point, then you will be doing yourself a good service by writing for the CANDLER "BOOK OF FACTS." This book gives full details of the Candler System of Morse Code training; it is free and to write for it does not place you under the slightest obligation.

YOU will be interested in the ADVANCED COURSE. Read the following extracts from two Candler students' letters.

"I can now read plain language at about 30 w.p.m., and copy at this speed." . . . "My ability to copy behind has also increased lately, and copying press is now a pleasure instead of a somewhat trying job."

J.E.L. Ref. 152.

"I can now send at a comfortable 30 w.p.m. and can read quite long sentences at a speed just under that."

J.C.B. Ref. 8794.

The Originals of above letters may be inspected at the London Office.

There are Candler Morse Code Courses for Operators & Beginners. Send for Free "Book of Facts."

THE CANDLER SYSTEM CO. (Room 55W), 121, KINGSWAY, LONDON, W.C.2 Candler System Co., Denver, Colorado, U.S.A.

G. L. BROWN, Eng. Designer.—Design, development and construction of electro-mechanical apparatus and small mechanisms. —6, Glenby Ave., Gt. Crosby, Liverpool, 23.

TO radio manufacturers, wholesalers and factors.—Enquiries are invited for wave wound r.f. coils, a.f. chokes, transformers and inductance-resistance sub-assemblies; reliable work and keen prices assured.—Morgan Dawes and Co., Ltd., 18, Crescent St., Weymouth.

RADIO partnership.—Trained music lover with up to £1,000 capital would like to meet sound radio man with similar capital to start music and radio business; advertiser is aged 30, anticipating demobilisation within 12 months.—Write in confidence to Box 3482.

SYNCHRONOUS motors, Sangamo, 200-250 volts ac, 50c, self-starting, fitted reduction gears; ideal movements for time switches, industrial, darkroom, electric clocks, etc.; rotor speed 200 rpm, final speeds available: 1 rev 12mins, 22/6; 1 rev 30mins, 25/-; 1 rev 60mins, 25/-; consumption 2 1/2 watts; size 2 1/2 x 2 1/4 x 1 1/4.

MOVIING coil headphones, p.m., energised by Alni magnets, 45 ohms, 1/2 in coil, ideal for mikes, miniature loudspeakers, etc.; 1 1/2 in overall, in bakelite cases, with 3in front flange, 7/6 each; per pair, with headband, 16/6.

MOVIING coil mike insets in metal cases, 8/6 each; fitted as hand mike, with switch in handle, 12/6, post paid.

PROJECTION lenses, lin focus, ideal for 9.5 or 16mm films, soundheads, etc., oxidised mounts, 1 1/2 in long, 3/4 in diameter; 5/- each; terms, cash with order. Regd. post and packing 1/- extra.—H. Franks, Scientific Stores, 58, New Oxford St., W.C.1. Mus. 9594. [3924

SITUATIONS VACANT
MANAGER experienced in radio production, offered permanent post with good prospects.—Box 3472. [3880

TO Class A ex-Servicemen.—Assistant manager (service department) required for well-known radio manufacturer, London area; sound technical knowledge of radio and television; experience in administration and record.—Write, stating age and full particulars to Box 7259, A.K. Adv., 212a, Shaftesbury Ave., W.C.2. [3903

A.S.E. London factory has vacancies for experienced engineers preferably having previous experience of the design of radio and television receivers and the application of radio to vehicles, excellent post-war prospects; appointment when present restrictions are withdrawn.—Write in confidence to Box 7189, A.K. Adv., 212a, Shaftesbury Ave., London, W.C.2. [3903

A PPLICATIONS are invited from Class A ex-Servicemen for draughtsmen required immediately by leading manufacturers in London area, for design department working on radio and television equipment; previous experience essential; good prospects.—Write, stating age and full particulars, to Box 7246, A.K. Adv., 212a, Shaftesbury Ave., W.C.2. [3903

PRODUCTION and commercial manager (not under 35) required for radio and electrical factory employing one hundred hands; sound knowledge of modern works practice and processes required, with ordinary ability to handle commercial correspondence; experience of press work, spot welding, capstans, etc., essential.—Full particulars, age, salary, to Box 3486. [3954

CATHODE ray tube engineer required, University trained with at least 10 years' experience of cathode ray tube development and manufacture, must possess initiative to follow a new type through to the shop and ensure economical manufacture; appointment will be made after relevant restrictions are withdrawn.—Write in confidence to Box 7194, A.K. Adv., 212a, Shaftesbury Ave., London, W.C.2. [3885

RADIO valve engineer required, University trained, with at least 10 years' experience of valve development and manufacture, must possess initiative to follow a new type through to the shop and ensure economical manufacture; appointment when relevant restrictions are withdrawn.—Write in confidence to Box 7191, A.K. Adv., 212a, Shaftesbury Ave., London, W.C.2. [3884

TEST gear and maintenance engineer required by manufacturers in S.E. London; applications are invited from Class A ex-Servicemen experienced in diagnosis and repair of electronic test and measuring equipment, capable of designing simple jigs and fixtures.—Write, giving full details, age and experience to Box 7249, A.K. Adv., 212a, Shaftesbury Ave., W.C.2. [3900

REQUIRED, technical assistant for commercial department of Radio Valve Works, North London District, a good knowledge of radio engineering is essential and some commercial experience is desirable; no offer of engagement can be made until the relevant Restriction on Engagement Orders are withdrawn.—Applications, with details of qualifications, age, experience, etc., to Box 3470,

8 + 8 MFD

Condensers are components mostly required nowadays. Sometimes we have a small supply which is distributed at the official price. At present we are offering well-known makers' products 100% guaranteed by us:

VALVE HOLDERS. All bases in stock, 1/-.
DIALS. Medium wave stations printed, 1/7.
TWO-GANG CONDENSERS. Special midget condensers, with trimmers, 15/6.
THREE-GANG CONDENSERS. Standard type, 12/6.

MAIN TRANSFORMERS. RMR 200/230 volts 300-0-300, 4 v. 4 amps, 4 v. 2 amps, 6.3 v. 3 amps, 5 v. 2 amps, 37/6.
SPEAKER TRANSFORMERS. Universal output (Pentode and Power), 6/9. Universal model, 9/-.
VOLUME CONTROLS. Most values in stock, with switch, 6/-.
POTENTIOMETER. Wire wound, variable, 0-10 ohms, complete with knob, 3/9.
TRIMMER SCREWDRIVERS. Non-capacity ebonite, 1/9 each.

RESISTORS. 1 watt, card of 36 assorted values, 27/6; 1 watt, 24/-.
VARIABLE MADE DROPPER RESISTORS. .2 or .3 amp, 5/8. Resistor in cages to permit fixing outside set, 3 amp, 740 ohms, 11/9.
TRF COILS. Set of medium wave coils (Aerial and H.F.), complete with diagram, 9/6.
LINE COIL. 2-core, .3 amp, 60 ohms, per foot 1/-; 3-core, .3 amp, 60 ohms, per foot 1/1; 3-core, .15 amp, 100 ohms, per foot 1/2.

SPEAKERS. 8in. Bola, less transformer, 23/-; 6 1/2in. Celestion, with transformer, 27/-; 3 1/2in. Goodman, less transformer, 30/-.
VIBRATORS. Brand new American "MALLORY," 6 v. 4-pin, fully guaranteed, 13/6.

MODERN AIDS
"TESTSCOPE," the best pocket instrument for tracing faults. Enables 20 tests A/O/D, complete with leads, 37/6.
TRIMMER TOOL KITS. 14 tools in wallet, 30/-.
"ELCO" Electrical Light-weight Soldering Iron (state voltage), 13/6. "FLIX-O-DISK," a novel calculator of Ohm's law problems, 8/8.
MOVING COIL METERS. 30 amps, charge, discharge, bakelite base, 19/6.
CAR AERIALS. telescopic, nickel-plated, 21/-.
ELECTRIC TEA KETTLES, 200/240 v., 63/-.

RADIO LITERATURE
Equivalent Charts, our unique booklet, 1/7.
Handbook on American Midget Sets, 2/7.
Manual of British and American Valves, 3/6.
Radio Inside Out, 4/9.
Radio Simplified, 4/9.
Basic Radio, 5/3.
Introducing Radio Servicing, 6/3.
Receiver Circuits Book, 6/3.
Various Service Books, 10/6 per doz.
Various Service Diagrams, 7/6 per doz.
Giant World Radio Map, 5/-.
VALVES. See advertisement, June issue.
Orders under 10/- C.W.O., otherwise C.O.D. Stamp with enquiries, please. B.O.T. Retail prices.

MORE EXPORT ORDERS INVITED.

J. BULL & SONS
(Dept. W.W.)
246, HIGH STREET,
HARLESDEN, N.W.10

POST-WAR TELEVISION

The advance in Radio Technique offers unlimited opportunities of high pay and secure posts for those Radio Engineers who have had the foresight to become technically qualified. How you can do this quickly and easily in your spare time is fully explained in our unique handbook.

Full details are given of A.M.I.E.E., A.M.Brit.I.R.E. City & Guilds Exams, and particulars of up-to-date courses in Wireless Engineering, Radio Servicing, Short Waves, Television, Mathematics, etc., etc.

We Guarantee "NO PASS—NO FEE"

Prepare for to-morrow's opportunities and post-war competition by sending for your copy of this very informative 112-page guide NOW—FREE.

BRITISH INSTITUTE OF ENGINEERING TECHNOLOGY (Dept. 388)
17, Stratford Place, London, W.1

RADIO engineer consultant required; an industrial firm interested in the construction and application of h.f. heating units and application of electronics to particular industrial problems would like to retain services of a consultant who can advise on certain problems, work-out circuits.—Box 3476.

A WELL-KNOWN and long-established manufacturer of radio components requires a chief mechanical engineer; excellent opportunity for a man with good qualifications and experience in mechanical design; appointment when present restrictions of employment are withdrawn.—Box 3485. [3933]

BELLING and LEF, Ltd., require the services of sales engineers for London and the country; qualifications in electrical and/or radio engineering essential, but established sales connections are not required; positions are permanent, and applications will be considered from class A ex-Servicemen.—Application forms will be sent in response to written replies only, to Cambridge Arterial Rd., Enfield. [3940]

SITUATIONS WANTED

HONOURS graduate, 29, regular contributor to "Wireless World," etc., requires post of literary or instructional nature in London area.—Box 3473. [3881]

DEVELOPMENT engineer, with industrial electronic experience, wishes to contact a progressive firm with view to employment, London area desirable.—Box 3467. [3856]

ENGINEER, 15 years' experience cinema sound and projection equipment, supervision installation and maintenance, previous P.A., radio and electrical training, desires change; responsible post.—Box 3481. [3921]

TUITION

LEARN Morse code the Candier way.—See advertisement on page 31. [1292]

RADIO training.—P.M.G. exams and I.E.E. Diploma; prospectus free.—Technical College, Hull. [0611]

A POSTAL training in electrical engineering—power or radio; individual correspondence tuition by highly qualified engineers with wide teaching and technical experience. Elementary or advanced courses. Preparation for recognised examinations. Pre-service training specially arranged.—G. B., 18, Springfield Mount, Kingsbury, N.W.9. [1731]

REWINDS

Armatures, Fields, Transformers, Pick-ups, Fractional H.P. Motors, Speakers Refitted New Cones & Speech Coils.

All Guaranteed and promptly executed.

Valves, B.V.A. and American, good stocks. Send stamped addressed envelope for list of Radio Spares, and G.O.D. Service.

A.D.S. Co. 261-3-5, Lichfield Road, ASTON, BIRMINGHAM, 6

BATTERY CHARGERS & TRICKLE CHARGERS



Trouble-free Chargers fitted with selenium all-metal rectification. Good allowance on your old Charger. Thirty years experience behind every Runbaken product. Booklet B.15, describing 12 Models, on request.

RUNBAKEN-MANCHESTER 1

TRANSFORMERS for SOUND EQUIPMENT

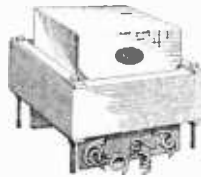

New Improved K450H, 50/-

On larger laminations previously reserved for priorities, now released for general sale, 450-0-450 v. 250 ma. 0-4-5 v. amp. for rectifier, two 6.3 v. 4 amp. c, t, LT's, for 6L6's or 807's.

Output and Driver units to suit. All our transformers are fitted with steel covers and clamps.

Audio amplifier circuits for 15, 20, 32, 65 watts, full scale, 2/6 each.

Complete amplifiers, etc., from £12. 10. Write for lists T55 and V65.

RADIO INSTRUMENT CO.
Radio Products
294, BROADWAY, BEXLEYHEATH, KENT

COVENTRY RADIO

Component Specialists since 1925

	s.	d.
2-GANG CONDENSERS, 1st Grade.....	12	0
OUTPUT TRANSFORMERS, 70 ma tapped pri.	6	9
L.F. CHOKES, 75 ma, 12 and 20 h.....	6	9
MAINS TRANSFORMERS, 350-0-350 volt,		
80 ma, 6.3 volt 3 amp., 5 volt 2 1/2 amp.	26	6
MAINS TRANSFORMERS, with 4 v. 4 a. and		
4 v. 2 1/2 a.....	26	6
VOLUME CONTROLS, Best makes, with switch	4	9
VOLUME CONTROLS, Best makes, less switch	3	9
OAK SWITCHES, 1 pole 11 way.....	4	6
VARIABLE RESISTORS, Wire wound 3 3 and	5	9
5 9		
SESTOFLEX SLEEVING, 1/2 mm. per dozen	3	6
RESISTOR KIT, Erie, Morganite, etc. New		
stock, 20 assorted, 1/2, 1 and 2 watt.....	10	6

SEND FOR OUR LATEST LIST "H."
PROMPT SERVICE, COMPLETE SATISFACTION
THE COVENTRY CO.
191, DUNSTABLE ROAD, LUTON

MATHEMATICS.—Expert personal postal tuition; Matric, Inter, radio maths.—Prospectus and advice free from S.T.T.C., 8, Acupart House, Portswood, Southampton.

RADIO Engineering.—Television and Wireless Telegraphy, comprehensive postal courses of instruction.—Apply British School of Telegraphy, Ltd., 179, Clapham Rd., London, S.W.9 (Estd. 1906). Also instruction at school in wireless for H.M. Merchant Navy and R.A.F. [3949]

THE Tuitionary Board of the Institute of Practical Radio Engineers have available home study courses covering elementary, theoretical, mathematical, practical and laboratory tuition in radio and television engineering; the text is suitable coaching matter for I.P.R.E., Service-entry and progressive exams.; tuitionary fees—at pre-war rates—are moderate.—The Syllabus of Instructional Text may be obtained post free from the Secretary, Bush House, Walton Avenue, Henley-on-Thames, Oxon. [1452]

PATENT NOTICES

THE proprietors of British Patent No. 504934, entitled Improvements in Closures for Evacuated Envelopes and Method of Manufacturing the Same, offers same for license or otherwise to ensure its practical working in Great Britain.—Inquiries to Singer, Ehler, Stern and Carlberg, Chrysler Building, New York City 17, N.Y., U.S.A. [3887]

RADIO-electric patents.—Well-known London radio component manufacturers are open to consider patents or designs for post-war period.—Write Progress, c/o Alfred Bates & Son, Ltd., 130, Fleet St., London, E.C.4.

BOOKS, INSTRUCTIONS, ETC.

BOOKS on Radio.—We have the finest stock in the country, including many that are out of print. Write or call for complete list, price list.

THE Modern Book Co. (Dept. W.3), 19-23, Praed St., London, W.2. Paf. 4185. [3867]

WEBB'S radio map of the world locates any station heard, size 40x30in, 4/6, post 6d.; on linen, 10/6, post free.—Webb's Radio, 14, Soho St., W.1, Gerrard 2089.

167 copies "W.W.", 1936-1944, some older ones missing; 12 copies "Electronic Eng.", 1944; 6 copies "W. Eng."; 8 copies "Radio-Craft", etc.; all clean; 195 copies. £5.—Box 3479. [3914]

Radio Servicemen

How would you like: (a) to receive a monthly ration of 12 electrolytics? (b) to be able to borrow receiver service sheets? (c) to be able to get practically any valve or spare? (d) to receive an interesting bulletin fortnightly? All these and other advantages cost you only 7/6 yearly. One condition only: you must be running a regular spare or full-time radio repair service. Write enclosing 7/6 requesting to be made a member of V.E.S.

V. E. S. (W), Radio House, Ruislip, Middx.

WARD ROTARY CONVERTERS

Petrol Electric Generating Plants, H.T. Generators, D.C. Motors, Frequency Changers, etc., up to 25 K.V.A.

CHAS. F. WARD
37, WHITE POST LANE, HACKNEY WICK, E.9
'Phone: Amherst 1393

SOUND SALES

TRANSFORMERS—QUALITY RADIO & AMPLIFIERS.
WEST ST., FARNHAM, SURREY.

PREPARING TO GIVE YOU THE BENEFIT OF EXTRA INVALUABLE EXPERIENCE GAINED ON WAR SERVICE

ESTABLISHED 1930.

ARMSTRONG

ARMSTRONG has always had the name for Quality.

When this war has been brought to a successful conclusion our new range of ARMSTRONG CHASSIS will prove that our reputation will built on a firm foundation.

ARMSTRONG WIRELESS & CO. LTD.
WALTERS ROAD, HOLLOWAY, LONDON, N.7

'Phone: NORTh 3213

ELECTRONIC AIDS *for* INDUSTRY



To all outward appearances, these two sections of steel bar are identical, yet their composition and properties may be totally different. One may be quite unsuited to the job that the other could perform with ease.

Until electronics provided a method of instant identification, checking up materials against specifications was a lengthy laboratory process, calling for special training and skill.

Now with the aid of an electronic instrument and the use of the thermoelectric effect, the material to be tested is compared directly with the known sample and rapid identification is achieved.

So electronics lends yet another helping hand to industry—speeding production and obviating rejects caused by unsuitable material. As makers of Capacitors for all purposes, we are concerned with every new electronic achievement and are constantly developing types to meet new applications.

We invite you to submit your capacitor problems to us.



A. H. HUNT LTD • LONDON • S.W. 18 • ESTABLISHED 1901

Be safe, use ERSIN MULTICORE SOLDER

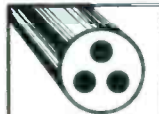

3 CORES OF FLUX

Three cores of flux distributed over the cross-section of the solder provide thin solder walls and exactly the correct proportions of solder to flux. This gives rapid melting, ensures flux continuity and high-quality joints, and avoids waste. No extra flux is required. Ersin Flux is the fastest non-corrosive flux, enabling joints to be made speedily on oxidised surfaces. The use of Ersin Multicore Solder with correct soldering technique avoids "H.R." or dry joints.

10 SWG 22 SWG

Ersin Multicore Solder is made in most gauges between 10 and 22 S.W.G. (.128—.028") (3.251—.7109 m/ms). For general radio and electrical production and maintenance 13 and 16 S.W.G. are in most demand.

Virgin Tin & Lead

Five alloys of Ersin Multicore Solder, made from virgin metals, are available—all antimony free. Under present circumstances 45% tin and 55% lead is the most widely used alloy.



TECHNICALLY, Ersin Multicore Solder is far superior to any other cored solder. A practical laboratory or production test will demonstrate this and show you that it is the most economical solder to use. The majority of British and overseas manufacturers already enjoy the advantages of Multicore. If you do not, and are engaged upon radio manufacture or maintenance, write for further technical information and free samples.

Single reel rate nominal 1 lb. reels.

13 SWG - 4/10
16 SWG - 5/3

Above prices subject to usual discount. ¼ cwt.—ton lots at bulk rate. 6d. cartons for home use, available at most good radio and electrical dealers, ironmongers, etc.